

Automatic Multimeter PM2519

Service Manual

9489 475 02111
870306

A large, irregular black shape with rounded corners and a notch on the right side, serving as a background for the I&E logo.

I&E

Industrial & Electro-acoustic Systems Division



Industrial &
Electro-acoustic Systems

PHILIPS

Automatic Multimeter

PM2519

Service Manual

9489 475 0211
870309

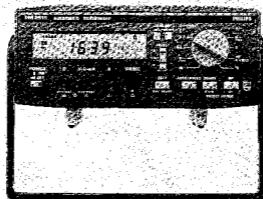

87410-51

IMPORTANT

This service manual is based on instruments with a serial number DY 01 3811 and onwards.

In chapter 9, modifications to the PM 2519, an overview is given of modifications in the earlier instruments.



PHILIPS

IMPORTANT

In correspondence concerning this instrument, please quote the type number and serial number as given on the type plate.

NOTE: *The design of this instrument is subject to continuous development and improvement. Therefore the instrument may not exactly comply with the information in the manual.*



PHILIPS

SERVICE

Scientific & Analytical Equipment
Test & Measuring Instruments
Industrial Automation
Advanced Automation Systems
Welding

Scientific &
Industrial
Equipment
Division

840917

PM2519

SME116

Already issued: --

Re : Accuracy counter level

As documentation for the PM2519 the service manual 9499 475 02111 and this information sheet should be used.

Problem: Signals with a level between 1,5V and 1,8V peak-peak 100 KHz cannot be measured with the PM2519.
Specified is that signals must not be lower than 1,5V 100 KHz.

Remedy : Replace resistor R1306 for a resistor with a value of 64K9 (orderingnumber 5322 116 50514).

Note : All the instruments to be repaired must be adapted

PM2519/01 serialnumber lower than DY 01 01 711

PM2519/21 serialnumber lower than DY 21 00 726

PM2519/51 serialnumber lower than DY 51 01 061



PHILIPS

SERVICE

Scientific & Analytical Equipment
Test & Measuring Instruments
Industrial Automation
Advanced Automation Systems
Welding

Scientific &
Industrial
Equipment
Division

841205

PM2519

SME117

Already issued: SME116
Re : Mains interference

As documentation for the PM2519 the service manual 9499 475 02111, SME 116 and this information sheet should be used:

Problem: The display shows the previously displayed value, (e.g. the display does not change) and does not react to manual or remote operation.

Cause : Mains interference will sometimes hang up the I²C bus of the microprocessor. The microprocessor of the IEC-625/IEEE-488 interface can also cause these problems .

Remedy : Replace capacitor C1600 for a capacitor with a value of 2200 uF 16V. (ordering number 5322 116 50514).
Proceed as follows:
- Unsolder C1600 and remove it
- Place the mentioned capacitor (the (-) connection is the same, the (+) connections are the two last points of the mains switch) (see fig 1.)

Note : All the instruments to be repaired, with the following serial numbers, must be modified:

PM2519/01 serial number lower than DY 01 01 411
PM2519/21 serial number lower than DY 21 00 626
PM2519/51 serial number lower than DY 51 01 766

9499 478 14811

PRINTED IN THE NETHERLANDS

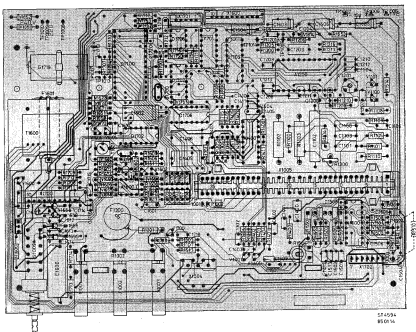

Fig. 1. Main p.c.b., lay-out, component

CONTENTS

Page

1. TECHNICAL DATA	1-1
1.1. General	1-1
1.2. DC voltage measurements	1-1
1.3. dB measurements in DC ranges	1-2
1.4. AC voltage measurements	1-2
1.5. dB measurements in AC ranges	1-3
1.6. DC current measurements	1-3
1.7. AC current measurements	1-4
1.8. Resistance measurements	1-4
1.9. Diode measurements	1-5
1.10. Continuity check	1-5
1.11. Temperature measurements	1-5
1.12. Frequency measurements	1-8
1.13. Relative reference measurements	1-6
1.14. Conversion characteristics	1-6
1.15. Visual representation	1-7
1.16. Operating conditions in accordance with IEC-359	1-7
1.17. Mains supply conditions in accordance with IEC-359, group S2	1-7
1.18. Battery supply (PM2519/21 version only)	1-7
1.19. Input terminals arrangement	1-8
1.20. Time function ADC	1-8
1.21. Warm-up time	1-8
1.22. Calibration	1-8
1.23. Accessoires	1-8
1.24. Miscellaneous	1-8
1.25. Safety	1-8

2.	CIRCUIT DESCRIPTION	2-1
2.1.	General	2-1
2.2.	Survey of the sections	2-2
2.2.1.	Analog section	2-2
2.2.2.	Digital section	2-3
2.2.3.	Display section	2-3
2.3.	Functional section	2-4
2.3.1.	General	2-4
2.3.2.	Analog section	2-4
2.3.2.1.	DC voltage measurements	2-4
2.3.2.2.	Alternating voltage measurements	2-5
2.3.2.3.	DC current measurements	2-6
2.3.2.4.	Alternating current measurements	2-7
2.3.2.5.	Resistance measurements	2-7
2.3.2.6.	Diode measurements	2-8
2.3.2.7.	Temperature measurements	2-8
2.3.2.8.	Frequency measurements	2-9
2.3.3.	RMS converter	2-12
2.3.4.	Analog to digital converter	2-13
2.4.	Digital section	2-14
2.4.1.	ADC interface	2-14
2.4.1.1.	Overview ranges	2-16
2.4.2.	Microcomputer	2-17
2.4.3.	I ² C interface	2-18
2.4.4.	Measuring sequence	2-19
2.4.5.	Control inputs	2-21
2.4.6.	RAM	2-22
2.5.	Display	2-22
2.6.	Power supply	2-23
2.7.	PM2519/21	2-23
2.7.1.	General	2-23
2.7.2.	Charging circuit	2-23
2.8.	PM2519/51	2-24
2.8.1.	IEC-625/IEEE-488 interface	2-24
3.	CHECKING AND ADJUSTING	3-1
3.1.	General	3-2
3.2.	Adjusting the PM2519 with the aid of a controller	3-3
3.3.	Part A	3-6
3.4.	Part B	3-8
3.5.	Adjusting the battery power supply	3-13

4. FAULT-FINDING		4-1
4.1.	General	4-1
4.1.1.	Service hints	4-1
4.1.2.	Fault-finding procedure	4-2
4.2.	Fault-finding flowcharts	4-2
4.2.1.	Initial test	4-2
4.2.2.	Function part test	4-3
4.2.3.	Vdc, mV and I_{cc} > preset test	4-4
4.2.4.	Vac part test	4-5
4.2.5.	Adc part test	4-6
4.2.6.	Aac part test	4-7
4.2.7.	Ohm part test	4-8
4.2.8.	Hz part test	4-9
4.2.9.	ADC part test	4-10
4.2.10.	Digital part test	4-11
4.2.11.	Display part test	4-12
4.2.12.	Power supply test	4-14
4.2.13.	Galvanic separation test (PM2519/51)	4-15
4.2.14.	IEC-bus test (PM2519/51)	4-16
5. ACCESS		5-1
5.1.	Dismantling the PM2519	5-1
5.2.	Dismantling the battery power supply (PM2519/21)	5-5
5.3.	Dismantling the IEC-bus and the galvanic separation	5-6
6. PARTS LIST		6-1
6.1.	Main pcb	6-1
6.1.1.	Resistors	6-1
6.1.2.	Capacitors	6-2
6.1.3.	Semi-conductors	6-4
6.1.4.	Integrated circuits	6-5
6.1.5.	Miscellaneous	6-5
6.2.	Additions to the parts list for PM2519/21 (battery version)	6-7
6.2.1.	Resistors	6-7
6.2.2.	Semi-conductors	6-7
6.2.3.	Capacitors	6-7
6.2.4.	Integrated circuits	6-8
6.2.5.	Miscellaneous	6-8
6.3.	Additions to the parts list for PM2519/51	6-9
6.3.1.	Galvanic separation	6-9
6.3.1.1.	Resistors	6-9
6.3.1.2.	Capacitors	6-10
6.3.1.3.	Semi-conductors	6-10
6.3.1.4.	Integrated circuits	6-10
6.3.1.5.	Miscellaneous	6-11

6.3.2.	IEC-bus interface	6-12
6.3.2.1.	Resistors	6-12
6.3.2.2.	Capacitors	6-12
6.3.2.3.	Semi-conductors	6-12
6.3.2.4.	Integrated circuits	6-12
6.3.2.5.	Miscellaneous	6-12
7.	CIRCUIT DIAGRAMS AND PCB LAY-OUT	7-1
8.	ADAPTING TO THE LOCAL MAINS	8-1
8.1.	PM2519/01/21	8-1
8.2.	PM2519/51	8-1
9.	MODIFICATIONS	9-1
9.1.	Modifications to the PM2519/01	9-1
9.2.	Modifications to the PM2519/51	9-3
10.	COMPONENT DATA	10-1

1. TECHNICAL DATA

All values mentioned in this description are nominal; those given with tolerances are binding and guaranteed by the manufacturer.

1.1. GENERAL

Manufacturer	: PHILIPS HIG S&I
Type number	: PM 2519
Designation	: Digital multimeter
Measured functions	: V_{rms} , $V_{\text{~}}$, dB, A_{rms} , $A_{\text{~}}$, Ohm, \rightarrow , \square , °C, Hz, zero suppression

(Terms used in these specifications are based on definitions laid down in IEC 485.)

1.2. DC VOLTAGE MEASUREMENTS

Ranges	: 100 mV*, 1 V, 10 V, 100 V, 1000 V 1 V, 10 V, 100 V, 1000 V with audible tone for input signals > preset
(max. input voltage in highest range)	: 1000 V
Resolution	: 10 μ V in 100 mV range
Number of representation units	: 11000
Accuracy	: \pm (0.1% of reading + 0.02% of range)
Temperature coefficient	: \pm 0.015%/°C
Input impedance	: 100 mV range 1 M Ω \pm 1% 1 V, 10 V range 10 M Ω \pm 1% 100 V, 1000 V range 9,11 M Ω \pm 1%
Offset current in input	: < 20 pA
SMRR	: 60 dB for a.c. signals at 50 Hz \pm 0.1% 40 dB for a.c. signals at 50 Hz \pm 1%
CMRR	: > 100 dB for d.c. signals > 100 dB for d.c. signals 50/60 Hz
Maximum CM-voltage	: 250 V, 354 V _{peak}
Response time	: < 1 s including ranging < 0.5 s excluding ranging
Maximum input voltage between	: HI and LO 1000 V _{rms} ** HI and earth 1000 V _{rms} ** LO and earth 250 V _{rms}
Max. V-Hz product of input signal	: 10 ⁷
Zeroing	: Automatic
Zero point drift	: Included in accuracy and temp. coefficient
Relative reference setting	: With push-button "zero set on/off"
Audible tone	: For nominal voltage > preset value \pm 3 digits, on separate position function switch
High voltage sign	:  in display if $V_{\text{in}} > 110$ V



*) on separate position function switch

**) in 100 mV range 250 V_{rms}

1.3. dB MEASUREMENTS IN DC RANGES

Range	: -57 ... +43 dB (reference resistor 600 ohm) Measured value less than 1 mV is displayed as -UL, measured value > 110 V is displayed as OL and 
0 dB reference	: 1 mW in reference resistor or when selecting the relative reference function with push button "zero set on/off"
Reference resistors	: 50, 75, 93, 110, 125, 135, 150, 250, 300, 500, 600, 800, 900, 1000, 1200, 8000 ohms can be selected with preset knob
Resolution	: 0.1 dB for signals \geq 10mV 1 dB for signals < 10mV
Number of representation units	: 999 for signals \geq 10 mV 99 for signals < 10 mV
Accuracy	: Signals > 10 mV: 0.2 dB Signals \leq 10 mV: 1 dB
Temperature coefficient	: 0.0013 dB/ $^{\circ}$ C
Input impedance	: 10 M Ω \pm 1% for signals < 100 V 9,11 M Ω \pm 1% for signals \geq 100 V
CMRR	: > 100 dB for d.c. signals > 100 dB for a.c. signals 50/60 Hz
Response time	: < 1 s
Maximum input voltage between	: HI and LO 1000 Vrms HI and earth 1000 Vrms LO and earth 250 Vrms

1.4. AC VOLTAGE MEASUREMENTS

Ranges	: 1 V, 10 V, 100 V, 1000 V
(max. input voltage in highest range)	: 600 V
Resolution	: 100 μ V in 1 V range Measured value less than 0.2% of range is displayed as zero
Number of representation units	: 11000
Accuracy	: 40 Hz ... 1 kHz \pm (0.5% of reading + 0.1% of range)
(valid between 3% and 100% of range)	: 1 kHz ... 10 kHz \pm (1 % of reading + 0.1% of range) 10 kHz ... 20 kHz \pm (5 % of reading + 0.5% of range)
Temperature coefficient	: < 0.03%/ $^{\circ}$ C
Input impedance	: 1 V, 10 V range 2 M Ω \pm 1% 100 V, 1000 V range 1,802 M Ω \pm 1%
CMRR	: > 100 dB for d.c. signals > 80 dB for a.c. signals 50/60 Hz
Freq. range	: 40 Hz ... 20 kHz
AC detector	: rms converter, a.c. coupled
Crest factor	: 2 at full scale, indication () when crest factor exceeded
Response time	: < 2 s including, < 1 s excluding ranging
High voltage sign	:  in display if Vin 110 Vrms
Maximum input voltage between	: HI and LO 600 Vrms HI and earth 1000 Vrms LO and earth 250 Vrms

Maximum d.c. voltage	: 400 V
Maximum V-Hz product	: 10^7
Relative reference setting	: With pushbutton "zero set on/off"

1.5. dB MEASUREMENTS IN AC RANGES

Range	: -51 ... +43 dB (reference resistor 600 ohm). Measured value less than 2 mV is displayed as UL, measured value > 110 V is displayed as OL and
0 dB reference	: 1 mW in reference resistor or when selecting the relative reference function with push-button zero set on/off
Reference resistor	: 50, 75, 93, 110, 125, 135, 150, 250, 300, 500, 600, 800, 900, 1000, 1200, 8000 ohms can be selected with preset knob
Resolution	: 0.1 dB for signals ≥ 10 mV 1 dB for signals < 10 mV
Number of representation units	: 999 for signals > 10 mV 99 for signals < 10 mV
Accuracy for signals ≥ 80 mV	: 40 Hz ... 10 kHz ± 0.3 dB 10 kHz ... 20 kHz ± 1 dB
Signals > 10 mV < 80 mV	: 40 Hz ... 10 kHz ± 1 dB 10 kHz ... 20 kHz ± 4 dB
Temperature coefficient	: 0.003 dB/ $^{\circ}$ C
Input impedance	: 2 M Ω $\pm 1\%$ for signals < 100 V 1,802 M Ω $\pm 1\%$ for signals ≥ 100 V
CMRR	: > 100 dB for d.c. signals > 80 dB for a.c. signals 50/60 Hz
Freq. range	: 40 Hz ... 20 kHz
AC detector	: rms converter, a.c. coupled
Crest factor	: 2 at full scale, indication (\downarrow) when crest factor exceeded
Response time	: < 2 s
Maximum input voltage between	: HI and LO 600 Vrms HI and earth 600 Vrms LO and earth 250 Vrms
Maximum DC voltage	: 400 V
Maximum V-Hz product	: 10^7
Relative reference setting	: With push button "zero set on/off"

1.6. DC CURRENT MEASUREMENTS

Ranges	: 20 mA, 200 mA, 2 A, 20 A
(max. input current in highest range)	: 10 A (20 A for max. 20 sec.)
Resolution	: 10 μ A in 20 mA range
Number of representation units	: 2200
Accuracy	: \pm (0.5% of reading + 0.1% of full scale)
Temperature coefficient	: 0.05%/ $^{\circ}$ C
Voltage drop at end of range	: 20 mA, 2 A range < 60 mV 200 mA range < 300 mV at 10 A in 20 A range < 200 mV

Response time	: < 1 s including, < 0.5 s excluding ranging
Protected up to	: 250 mVrms range 20 mA, 200 mA, Range 2 A, 20 A, not protected max. current 20 A for 20 sec.
Max. CM-voltage	: 250 Vrms, 354 Vpeak
Maximum input voltage between	: HI and LO 250 Vrms HI and earth 250 Vrms LO and earth 250 Vrms
Relative reference setting	: With push-button "zero set on/off"

1.7. AC CURRENT MEASUREMENTS

Ranges	: 20 mA, 200 mA, 2 A, 20 A
(max. input current in highest range)	: 10 A (20 A for max. 20 sec.)
Number of representation units	: 2200
Resolutions	: 10 μ A in 20 mA range Measured value less than 20 digits is displayed as 0000
Accuracy	: 40 Hz ... 1 kHz : \pm (0.8% of reading \pm 0.1% of full scale)
(valid between 3% and 100% of range)	: 1 kHz ... 5 kHz : \pm (5 % of reading \pm 0.1% of full scale)
Temperature coefficient	: 0.05%/°C
Voltage drop at end of range	: 20 mA, 2 A range < 60 mV 200 mA range < 300 mV at 10 A and 20 A range < 200 mV
AC detector	: rms converter
Crest factor	: 9 at full scale; indication (\downarrow) when crest factor exceeded
Response time	: < 2 s including, < 1 s excluding ranging
Protected up to	: 250 Vrms range 20 mA, 200 mA, Range 2 A, 20 A, not protected; max. current 20 A for 20 sec.
Max. input voltage between	: HI and LO 250 Vrms HI and earth 250 Vrms LO and earth 250 Vrms
Relative reference setting	: With push-button "zero set on/off"
SMRR	: 14 dB for d.c. signals at full scale

1.8. RESISTANCE MEASUREMENTS

Ranges	: 1000 Ω , 10 k Ω , 100 k Ω , 1 M Ω , 10 M Ω
Resolution	: 100 m Ω in 1000 Ω range
Number of representation units	: 11000
Accuracy	: 1000 Ω ... 100 k Ω : \pm (0.3% of reading + 0.1 of full scale) 1 M Ω ... 10 M Ω : \pm (0.5% of reading + 0.1 of full scale)
Temperature coefficient	: 1000 Ω , 10 k Ω , 100 k Ω , 1 M Ω ranges: \pm 0.02%/°C 10 M Ω range: \pm 0.05%/°C
Measuring current	: 1 mA, 100 μ A, 10 μ A, 1 μ A, 100 nA, 10 nA
Maximum voltage at open input	: 3 V
Relative reference setting	: With push-button "zero set on/off"
Polarity input sockets	: - on HI + on LO

Response time	: < 2 s including ranging < 1 s excluding ranging in ranges 1 k Ω ... 1 M Ω , 1.5 s for 10 M Ω range
Protected up to	: 250 Vrms
Maximum input voltage between	: HI and LO 250 Vrms HI and earth 250 Vrms LO and earth 250 Vrms

1.9. DIODE MEASUREMENTS

Driving current	: 1 mA
Range	: 1000 mV
Protected up to	: 250 Vrms
Maximum input voltage between	: HI and LO 250 Vrms HI and earth 250 Vrms LO and earth 250 Vrms
Resolution	: 100 μ V
Number of representation units	: 11000
Relative reference setting	: With push-button "zero set on/off"
Polarity input terminals	: V/ Ω /mA negative, "0" positive

1.10. CONTINUITY CHECK

(Buzzer range)	: In diode range
Range	: Diode/buzzer
Driving current	: 1 mA
Short circuit	: Audible tone from 0 ... 10 Ω
Isolation	: Resistance > 10 Ω , no tone
Response time	: < 0.25 sec

1.11. TEMPERATURE MEASUREMENTS

Accessory required for temperature measurements	: Pt 100 probe
Range	: -50 $^{\circ}$ C ... +200 $^{\circ}$ C
Resolution	: 0.1 $^{\circ}$ C
Accuracy	: -50 $^{\circ}$ C ... 0 $^{\circ}$ C = \pm (3% of reading +0.5 $^{\circ}$ C) 0 $^{\circ}$ C ... 100 $^{\circ}$ C = \pm (1% of reading +0.5 $^{\circ}$ C) 100 $^{\circ}$ C ... 200 $^{\circ}$ C = \pm (2% of reading +0.5 $^{\circ}$ C)
Relative reference setting	: With push-button "zero set on/off"

1.12. FREQUENCY MEASUREMENTS

Range	: 1000 Hz, 10 kHz, 100 kHz, 1 MHz
Range selection	: ranges 10 kHz, 100 kHz, 1 MHz: manual or automatic range 1000 Hz: manual only
Resolution	: 0.1 Hz in range 1000 Hz
Number of representation units	: 11000
Accuracy	: $\pm 0.02\%$ of full scale
Gate time	
range 1 kHz	: 10 s
ranges 10 kHz, 100 kHz, 1 MHz	: 1 s
Conversion rate	
range 1 kHz	: 1 conv/10 s
ranges 10 kHz, 100 kHz, 1 MHz	: 1 conv/s
Input sensitivity	
10 Hz ... 100 kHz	: 1.5 V peak-peak
100 kHz ... 1 MHz	: 5 V peak-peak
Input attenuation	: automatically
Input impedance	: 2 M Ω
Coupling	: AC
Relative reference setting	: With push-button "zero set on/off"
Maximum input voltage between	
HI and LO	800 Vrms
HI and earth	600 Vrms
LO and earth	250 Vrms

1.13. RELATIVE REFERENCE SETTING

Last measured value	: By pressing push-button "zero set on/off"
Preset value (not for dB _{dc} and dB _{ac} measurements)	: By selecting the preset value and pressing push-button "zero set on/off". The preset value is a manual selected value, within the range of the number of representation units of the selected function.
Recall of the relative reference setting	: By pressing RCL knob

1.14. CONVERSION CHARACTERISTICS

Type of conversion	: linear
Operating principle	: delta modulation
Basic mode of operation	: repetitive triggered
Range setting	: automatic or manual by means of UP-DOWN steps
Polarity setting	: automatic on V ₋₋₋ , A ₋₋₋ , °C, trigger level dB and zero set

1.15. VISUAL REPRESENTATION

Range changing	: Range up at 2200 +0, -4 digits for [m] A \rightarrow [m] A \leftarrow ranges; 11000 +0, -4 digits for other ranges Range down at 200 \pm 4 digits for [m] A \rightarrow [m] A \leftarrow ranges; 1000 \pm 4 digits for other ranges
Means of representation of output value	: LCD, 11 mm, reflective Additional analog representation by means of bargraph in LCD
Means of polarity representation	: Automatic + and - in LCD
Means of function representation	: With the function selector on the text plate
Means of unit representation	: Automatic in the LCD
Means of overload representation	: LCD indicates OL
Means of decimal point representation	: Automatic, depending on the selected range in the LCD
Data hold	: By using Data Hold probe PM 9287
Range hold	: Possible via Man./Auto. switch

1.16. OPERATING CONDITIONS IN ACCORDANCE WITH IEC 359

Climatic conditions	: Group I of IEC 359 with extension of the temperature limit
Upper temperature limit	: +45 °C
Reference temperature	: +23 °C \pm 1 °C
Rated range of use	: \pm 0 °C ... 40 °C
Adjustment temp. range	: \pm 21 °C ... 25 °C (factory only)
Relative humidity	: 20 ... 80% non-condensing Max. dew-point 26 °C
Limit range of storage and transport	: -40 °C ... +70 °C
Mechanical conditions	: Group 2
From external origin	: Electric and electromagnetic fields Magnetic fields Ionizing radiation

1.17. MAINS SUPPLY CONDITIONS IN ACCORDANCE WITH IEC 359, GROUP S2

Reference value	: 220 V \pm 1%
Rated range of use	: 220 V \pm 10%
Note	: Instrument can be altered for nominal voltage 240 V
Mains supply frequency	
Reference value	: 50 Hz/60 Hz
Rated range of use	: 47 ... 63 Hz
Power consumption	: < 10 VA

1.18. BATTERY SUPPLY (PM 2519/21 version only)

Operating time	: > 20 hours
Charging time	: 18 hours

1.19. INPUT TERMINALS ARRANGEMENT

Number of sockets : 4 : LO, HI, 20 A, probe; asymmetrical floating

1.20. TIME FUNCTION ADC

Conversion rate : 2.5 measurements/s

Range changing time : 0.3 seconds

Recovery time overload for DC voltage ranges : < 5 seconds

1.21. WARM UP TIME

: 1 hour before calibration

1.22. CALIBRATION

Recalibration interval : 1 year

1.23. ACCESSORIES

Supplied with instrument : Measuring leads (incl. probe)
Mains supply cable
Fuses
Operating manual

Optional : Temperature probe PM 9249
EHT probe PM 9246
Current transformer PM 9245
HF probe PM 9210
Shunt PM 9244
Data hold probe PM 9267
Measuring leads PM 9260
Measuring leads PM 9266
Current gun PM 9101
HF probe PM 9213

1.24. MISCELLANEOUS

Dimensions (h x w x d) : 95 x 235 x 290

Weight : 2 kg

Cabinet material : ABS

1.25. SAFETY

Class : I, according IEC 348 for PM 2519/51 version,
II, for the other versions

2. CIRCUIT DESCRIPTION

2.1. GENERAL

The circuit of the basic Automatic Multimeter PM 2519 can be subdivided into three main functional sections as shown in Fig. 2.1.

- Analog section
- Digital section
- Display section

From the basic versions of the Automatic Multimeter the following type-numbers are derived:

- PM 2519/21 In the battery version (PM 2519/21) a rechargeable battery is used to supply the instrument with power.
- PM 2519/51 The PM 2519/51 version has a galvanic separation and an IEC-625/IEEE-488 bus interface for digital output data and remote control.

Each of the sections is described separately in conjunction with the overall circuit diagrams (Fig. 7.1., 7.2.). However, basic diagrams of the various stages are included, within the text, where considered necessary to assist in a better understanding of the complex parts of the overall circuit.

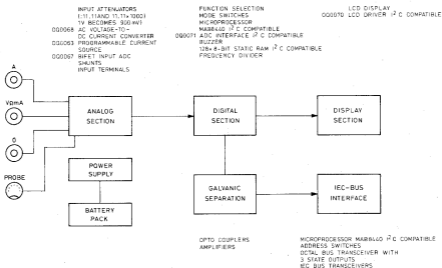

Fig. 2.1. Basic built-up of PM 2519

2.2. SURVEY OF THE SECTIONS

2.2.1. Analog section

The analog section comprises the following input measuring signal facilities:

- a. A voltage measuring path consisting of:
 - AC/DC voltage attenuators
 - RMS converter (OQ 006B)
 - ADC converter (OQ 0067)
 - ADC interface (OQ 0071)
- b. A current measuring path consisting of:
 - AC/DC current shunt
 - RMS converter
 - ADC
 - ADC interface
- c. A resistance/diode measuring path consisting of:
 - Current source (OQ 0063)
 - ADC
 - ADC interface
- d. A temperature measuring path consisting of:
 - Pt 100 input
 - ADC
 - ADC interface
- e. A frequency measuring path consisting of:
 - AC voltage attenuator
 - RMS converter (part of)
 - Dividing circuits

Note: The OQ integrated circuits used in this instrument are specially designed LSI circuits for multimeter applications to ensure high accuracy and stability.

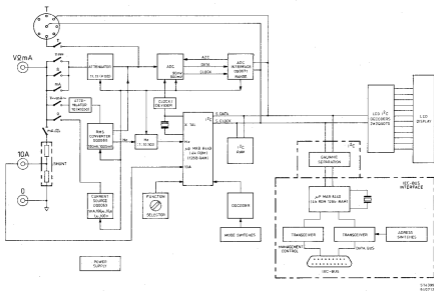

Fig. 2.2. Block diagram PM 2519

2.2.2. Digital section

- The microcomputer MAB 8440 (with internal ROM and RAM)
- The external RAM with battery back-up
- The function selector
- The mode switches with their decoding
- The ADC interface (FET switch control)
- The dividing circuits for the frequency measurements

2.2.3. Display section

The display section consists of:

- The display interface circuit
- The 4.5 digit liquid-crystal display

2.3. FUNCTIONAL DESCRIPTION

2.3.1. General

The automatic multimeter PM 2519 is designed around the microcomputer integrated circuit MAB 8440. The microcomputer has 4k internal ROM and 128 bytes RAM. It also comprises 20 quasi-bidirectional I/O parts, one serial I/O line and an 8-bit timer/event counter.

In combination with the ADC interface, the microcomputer controls the timing and measuring functions of the instrument. The communication between these devices is achieved by the aid of a serial bus, the so-called I²C-bus.

All the inputs are converted into d.c. signals and supplied to the ADC. The ADC in combination with the ADC interface converts these d.c. signals into digital logic signals and are sent via the I²C bus to the microcomputer.

2.3.2. Analog section

2.3.2.1. DC voltage measurements

The unknown voltage to be measured is passed to the d.c. attenuator where by means of resistors switched by FET switches, the attenuation factor is changed (Fig. 2.3.). Depending on the selection, the input voltage is attenuated 11.11 or 1111.11 times. The table indicates the attenuation factor for each range, the ADC input sensitivity and the range FETS.

The 11.11 attenuation is achieved with the resistors R1102, R1103 and the Ri of the ADC. The 1111.11 attenuation, which is switched on by the signal RNG D, is achieved by the voltage division of R1102, R1103, R1108 and the Ri of the ADC.

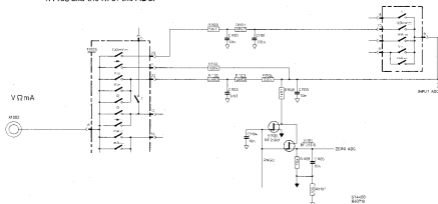

Fig. 2.3. DC attenuator

RANGE	ATTENUATION	RANGE		INPUT ADC	Ri PM 2519
		RNG D	RND E		
100 mV	1.11	—	0	90 mV	1 MΩ
1 V	11.11	0	0	90 mV	10 MΩ
10 V	11.11	0	1	900 mV	10 MΩ
100 V	1111.11	1	0	90 mV	9.11 MΩ
1000 V	1111.11	1	1	900 mV	9.11 MΩ

The 100 mV range is achieved by using a separate range. Attenuation is effected by means of R1110 and the Ri of the ADC.

2.3.2.2. Alternating voltage measurements

The input voltage to be measured is applied to the AC voltage attenuator, which changes the attenuation factor by means of RC-networks switched by a FET switch. The table for each range gives the attenuation factor, the RMS converter input sensitivity and the range signals.

The basic attenuation (10) is given by the voltage division of the components R1400, R1401//C1401, C1402 and R1404. An attenuation of 1000 is achieved by the basic attenuation and the resistors R1403 and R1402. The attenuation signal is then passed to the RMS converter, which produces a d.c. signal between 0 and 900 mV. Any d.c. component at the input is blocked by C1400.

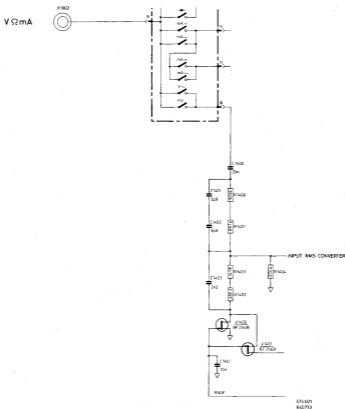

Fig. 24. AC attenuator

RANGE	ATTENUATION	AC INPUT RANGE	RANGE		Ri PM 2519	INPUT AC
			RNG F	RNG G		
1 V	10	100 mV	0	0	2 MΩ	900 mV
10 V	10	1000 mV	0	1	2 MΩ	900 mV
100 V	1000	100 mV	1	0	1.802 MΩ	900 mV
1000 V	1000	1000 mV	1	1	1.802 MΩ	900 mV

2.3.2.3. DC current measurement

In the function mA, two ranges (20 mA, 200 mA) are available. The ranges are determined by shunt R1301 and R1303 and the input impedance of the ADC. The ranges are protected by fuse F1300 (630 mA). If in case of measuring voltages, the function switch is changed to the (m)A function with the voltage still on the input terminals, then due to the low resistance of the shunts a high current is switched, which would normally damage the function switch. To prevent this, the (m)A function is protected by means of a switch position (m)A⁺. In this case the input is first connected with resistor R1300. If the input voltage at the input is too high then fuse F1300 will blow.

The high currents 2 A, 20 A to be measured are supplied to the A-socket. The ranges are determined by the shunt R1303 and the input impedance of the ADC. When inserted, the X1003 input socket, links the input socket with the base of transistor V1700, which sends a logic 0 to the I/O port of the microcomputer, to signal that the high current ranges have been selected.

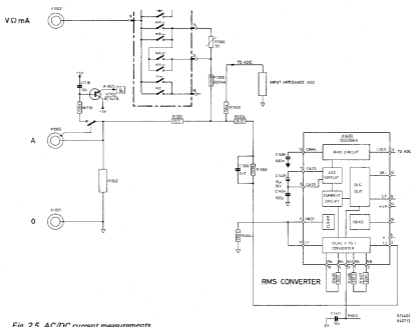

Fig. 2.5. AC/DC current measurements

RANGE	INPUT SENSITIVITY		RNG E
	ADC	INPUT	
20 mA	18 mV	mA socket	0
200 mA	180 mV	mA socket	1
2 A	18 mV	A socket	0
20 A	180 mV	A socket	1

2.3.2.4. Alternating current measurements

The ac input current ranges are shunted in the same way as the dc currents (refer to 2.3.2.3.). The voltage from the shunts is supplied to the I2 input of the RMS converter. Input I1 of the OQ 0061 is earthed via resistance R1404.

RANGE	INPUT SENSITIVITY	INPUT	RNG G	INPUT SENSITIVITY
	RMS			ADC
20 mA	20 mV	mA	0	180 mV
200 mA	200 mV	mA	1	180 mV
20 mA	20 mV	A	0	180 mV
200 mA	200 mV	A	1	180 mV

2.3.2.5. Resistance measurements

The unknown resistance is connected between the V, Ω , mA and 0 input socket and supplied internally by a constant-current source. This current results in a potential difference across the resistor that is proportional to the resistance value. The measuring currents in the OQ 0063 are derived from a reference current source I_{ref} adjusted by R1510 in parallel with resistor R1511. The output current I_{rc} of the reference current source feeds the current multipliers, to give the currents I_{rx} shown in the table, depending on the selected signal RNG A, RNG B and RNG C.

As stated, the voltage V_x developed across R_x is applied to the ADC for measurements. However, the ADC input resistance is finite (10 M Ω) and the small input current drawn by the ADC has to be compensated to avoid incorrect readings. This is achieved as follows: The voltage V_x across R_x is amplified by a factor of 2 in the compensation amplifier (+Vin) the gain being determined by the equal value resistors R1505 and R1503. The output voltage of 2 V_x appears at one end of R1506 and V_x is present on the other end. The voltage across R1506 is therefore $2V_x - V_x = V_x$. As R1506 is the input resistance of the ADC, the input current is compensated. In this way, the load imposed by the ADC is compensated as $I_{comp} = I_{adc}$:

$$I_{rx}' = I_{rx} + I_{adc} - I_{comp}$$

$$\text{so } I_{rx}' = I_{rx}$$

Protection for the current source is afforded by the PTC resistors R1500 and R1501, zener diodes V1550, V1553 and diodes V1551, V1552 and V1554.

In the event of a high voltage on the input terminals, the parallel network R1500//R1501 goes high resistance. To prevent part of I_{rx} leaking through the protection diodes, the anodes of V1554 and V1550 are connected to buffered V_x . The leakage current is zero because the voltage over the protection diodes is zero.

2.3.2.6. Diode measurements

Diode measurements and measurements of semiconductor junctions are performed in the same way as for resistance measurements in the 1000 Ω range, except for the input of the ADC. The unknown voltage across the diode is routed via R1110 to the ADC. This is done to get a quick response for the bleeper measurements. The value displayed is the voltage in forward or reverse direction across the diode in the highest range of the ADC. In the diode measuring range, the constant current derived from the OQ 0063 is 1 mA (see previous section).

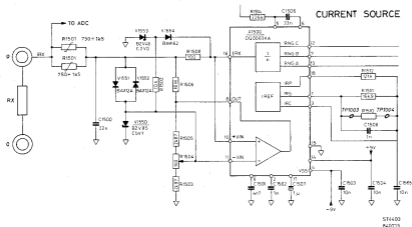

Fig. 2.6. Ohm measurements

2.3.2.7. Temperature measurements ($^{\circ}\text{C}$)

When the $^{\circ}\text{C}$ is selected, the constant current I_{rx} (1 mA) is routed from pin 2 of the probe connector X1004, which is connected via the probe to one end of the Pt-100 resistance thermometer. The other lead is connected to earth. This current gives a voltage drop which depends on the resistance value across the Pt-100 probe. The voltage drop is measured via two other points of X1004 (4-wire measurement). 0 $^{\circ}\text{C}$ will give a voltage of 100 mV. The 100 mV offset is subtracted in the microcomputer so that 0 $^{\circ}\text{C}$ will be displayed.

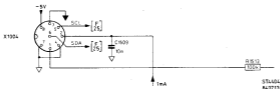

Fig. 2.7. Temperature measurements

2.3.2.8. Frequency measurements

The Hz function switch, connects the input signal to be measured via the attenuator to the RMS converter. The attenuator factor of the attenuator is 10 in all frequency ranges. The range of the RMS-converter is always 900 mV. Input SEL (RING H) is switched to logic 0. This means that the zero-crossing detection is enabled. The output CF will give a square wave with a frequency which is equal to the input frequency. The square wave is fed to a divider which divides the frequency by either 10 or 100. This depends on the frequency range which is selected. At the beginning of a frequency measurement, first select the highest range to see if the right range has been selected. This is done by means of enabling the 100 times divider.

FREQUENCY	DIVIDING	MEASURING TIME
1000 Hz	1	10 s
10 kHz	1	1 s
100 kHz	10	1 s
1 MHz	100	1 s

To create a 1000 Hz range the measure time is 10 s instead of 1 s.

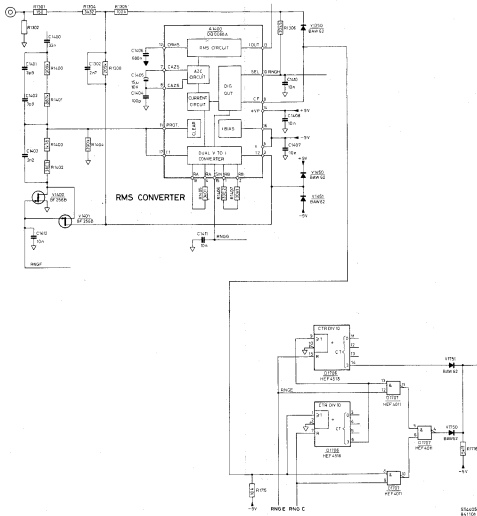

Fig. 2.8. Frequency measurements

2.3.3. RMS Converter

In the RMS converter the difference between the inputs I1 and I2 is converted into current in a dual V-I converter.

The current is determined by V_{in}/R and the state of the RNG G signal (where R is either R1405 or R1406+R1407). This RNG G from D1703 selects the input sensitivity of the RMS converter.

The current in the ac-to-dc converter is rectified and then converted into a current again by the RMS section. This current is proportional to the RMS value of the input signal. Capacitor C1406 is the integrating capacitor for the RMS section. Capacitors R1404 and C1405 provide the automatic zero (AZC) compensation for the RMS converter. The output of the RMS converter is converted into a voltage by resistor R1408.

In the RMS converter there is also an output to indicate whether the crest factor has been exceeded. When point 10 (RNG H) of the RMS converter becomes logic 1 on the CF (point 9) indicates to the microcomputer that the crest factor is exceeded. If RNG H is low then the output CF is switched to detect zero crossings. This is used to measure frequencies (see 2.3.2.8.).

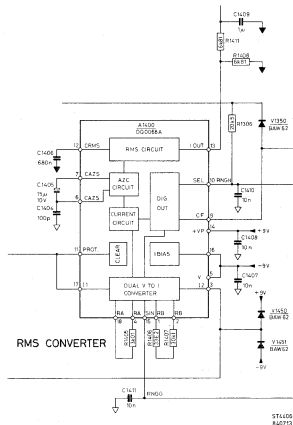

Fig. 2.9. RMS converter

2.3.4. Analog-to-digital converter

The ADC converts the analog signal into a digital signal by the delta modulation principle. Basically, the delta modulation ADC counts the difference in the time taken to charge and to discharge a capacitor about a fixed level, over a fixed period of time.

The number of charge/discharge cycles within this fixed time depends on the charge/discharge current which is made proportional to the unknown input voltage to the ADC. Therefore, the number of pulses counted within a fixed measuring period is proportional to the unknown voltage V_x . The obtained data signal is fed to the ADC interface D1703 where it is counted.

To obtain automatic zero i.e. counteract drift and internal offset, one complete measurement consist of two fixed measuring periods (two AZC periods).

One complete measurement is used to update the bargraph or for automatic ranging. However, a display result consist of two complete measurements.

During the first period of a measurement the AZC input is low and the ADC interface counts up on each clock-edge the logical state of the data signal. The value is kept in a register. During the second period, the data signal is inverted by the ADC interface and on each clock-edge the logical state of the input signal, the register is counted down. Also the input of the ADC is inverted so that offset in the result is compensated.

The ADC has two input sensitivities 90 mV and 800 mV, selected by the signal RNG E. This signal selects either R1211 or R1216 as conversion resistor.

ADC

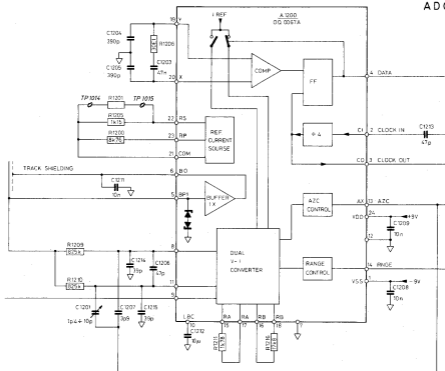

Fig. 2.10. ADC

2.4. DIGITAL SECTION

2.4.1. ADC interface

The information transport to this device is by means of an I^2C compatible interface (see 2.4.3.). This ADC interface is activated by a start condition so that it first reads an eight bit address. The four most-significant bits contain the group address, and the four least-significant bits contain a command to be executed by the device. This is in contradiction to the I^2C specification where these bytes are reserved for the device address.

The main purpose of the ADC interface is to count the number of clock-pulses within a given time period (T_2 , the measuring time) in which the data input is opposite to the AZC input of the ADC, plus the number of clock-pulses in another time period (T_2) in which the AZC signal has been inverted. The time periods are preceded by a waiting time T_1 (setting time). The figure below explains this sequence.

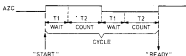

STL008
840720

Fig. 2.11. AZC period

At the end of this cycle the device generates a ready (READY) which interrupts the microcomputer. It instructs the microcomputer to read the internal counter of the ADC interface. The organisation should be such that when data continuously high and the number in T_2 is N , that at the end of the count-time the contents of the counter are also N .

Flow-chart of the sequence:

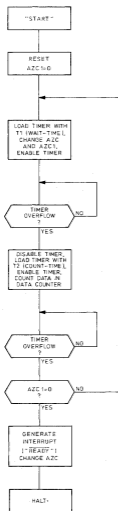

5T4409
840720

Fig. 2.12. Flowchart AZC period

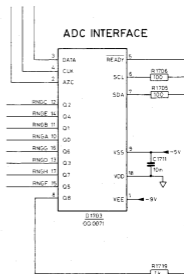

5T4410
840713

Fig. 2.13. ADC interface

Besides these functions, the ADC interface has eight output latches to control analog section (input sensitivities, output current OQ 0063 etc.). One of the latches is used to give an a.c. signal which is used for the bleeper.

2.4.1.1. Survey of ranges

Function	Range	DC ATTN	RING D	AC ATTN	RING F	OO 0088 RMS conv.	RING G	RING H	OO 0063 Current source	RING A	RING B	RING C	OO 0067 ADC	RING E
V_{rms}	100 mV*	1,11	0										90 mV	0
	1 V	11,11	0										90 mV	0
V_{\sim}	10 V	11,11	0										900 mV	1
	100 V	11,11x100	1										90 mV	0
	1000 V	11,11x100	1										900 mV	1
	1 V			10	0	100 mV							900 mV	1
A_{env}	10 V			10	0	1000 mV							900 mV	1
	100 V			10x100	1	1000 mV							900 mV	1
	1000 V			10x100	1	1000 mV							900 mV	1
	20 mA												18 mV	0
A_{\sim}	200 mA												180 mV	1
	2 A												18 mV	0
	20 A												180 mV	1
	200 mA					18 mV							180 mV	1
Ω	2 A					180 mV							180 mV	1
	20 A												180 mV	1
	1000 Ω	11,11	0							1			90 mV	0
	10 k Ω	11,11								0			90 mV	0
Hz	100 k Ω	11,11	0							10 μ A			90 mV	0
	1000 k Ω	11,11	0							1 μ A			90 mV	0
	10 M Ω	11,11	0							100 nA			90 mV	0
	1000 Hz				0	1000 mV	1	0						
dc	10 kHz				0	1000 mV	1	0						
	100 kHz				0	1000 mV	1	0						
	1 MHz				0	1000 mV	1	0						
*								0						1
								0						1

2.4.2. Microcomputer

The integrated circuit MAB 8440, one of the MCS-48 family of single-chip microcomputers, forms the basis of the digital section of the PM 2519. The MAB 8440 has an internal 4k ROM and 128 bytes RAM with address/data decoding facilities.

In addition to this, the 8440 has 20 quasi-bidirectional I/O ports. Data written to these ports remains unchanged until written. Each line is able to serve as input or output, or both, even through outputs are statically latched.

The microcomputer has been designed with an I²C bus to perform data transfer (see I²C).

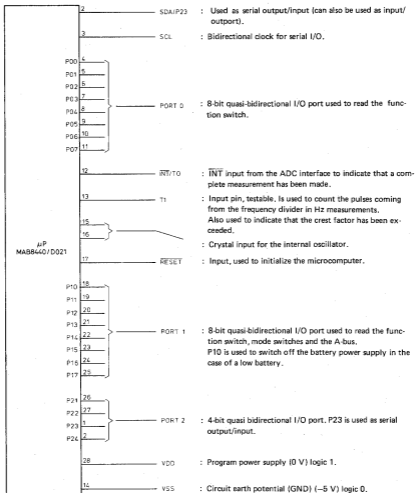

Fig. 2.14. Microcomputer

ST4411
840720

2.4.3. I²C interface

The I²C bus differs considerably from the conventional bus structures in that data-transfer is effected in a bit-serial, rather than in byte-parallel format.

In a conventional microcomputer such as the 8048 for instance, 12 address, 8 data and 4 control lines are necessary for parallel data transfer. The I²C 8440 microcomputer, on the other hand requires only 2 lines to transfer serially the same amount of data. Chips used for ADC, RAM and LCD drivers are I²C compatible and use also the same two lines.

These two lines are respectively the SDA (serial data line) and SCL (serial clock line) the function of which is to synchronise data-transfer between the appropriate I²C devices.

Almost any number of devices can be connected to the I²C bus. Each device is allocated its own specific 7-bit address, which enables any two of these devices to communicate with each other upon receipt of a message prefixed with the appropriate 7-bit address.

This specific 7-bit address usually comprises a fixed address part (4 bits), a user definable part (3 bits).

The latter being assignable by tying "Define Address" pins to high or low levels.

Address recognition is effected in the I²C interface hardware of each device, and this eliminates the need for decoding logic. The use of an automatic-invoked arbitration procedure, which prevents two or more devices from transmitting simultaneously, makes I²C technology eminently suitable for a multiprocessor system.

For an appraisal of the I²C data-transfer process, consider the operation of the PCD 8571, 1k-bit CMOS RAM, in conjunction with the 8440 microcomputer. When connected to the I²C bus this 8-pin RAM serves as a slave transceiver to the master processor. To transmit data to the RAM, the processor first transmits the specific 7-bit address, plus a Write Action Identifier bit.

The master processor then defines the specific location it wants to address, and starts to transmit its data.

Correct synchronisation between the devices is effected by the SCL (serial clock line).

For further information about I²C see: Philips data handbook; Integrated circuits for digital systems in radio, audio and video equipment.

2.4.4. Measuring sequence

After power on, the PM 2519 carries out some routines to measure and evaluate the input signal applied. The software applications are briefly indicated by the following sequence.

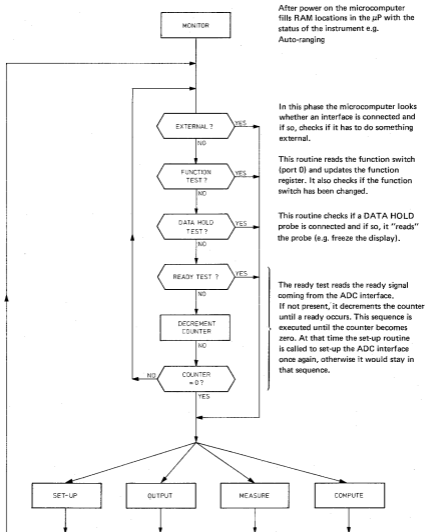

574412
840529

Fig. 2.15. Flowchart measuring sequence

Set-up routine: This routine sets-up the OQ 0071. The microcomputer reads the calibrated value out of the RAM and sends it to the OQ 0071. This device performs the necessary setting (e.g. range).

Output routine: The output routine starts the first (part) measurement. It gives the ADC the start command to perform the measurement. This routine displays also the previous measurement.

Compute: This routine reads the counter in the ADC interface and makes the necessary calculations.

Measure: The measure routine starts the second (part) measurement. The PM 2519 makes two measurements for one display result. The measurement is displayed in the output routine.

The sequence of a measurement is: set-up, output, compute, measure, compute, set-up, output, compute etc.

2.4.5. Control inputs

The ten function switches, when selected, provide a -5 V supply to one of the inputs of the microcomputer. The microcomputer reads a bit pattern on port 0 and knows which range is selected. The mode switches (push-buttons) are connected to a HEF 4532 an 8-input priority encoder. This encoder gives a binary bit pattern on the output and is also supplied to the microcomputer.

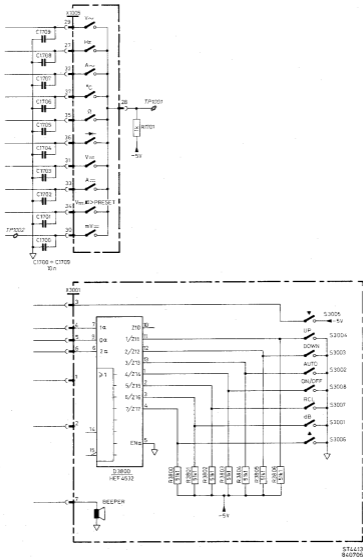

Fig. 2.16. Switch decoding

2.4.6. RAM

The external RAM in the PM 2519 is an I²C device; data and address are transferred serially via two lines. The organisation internal is 128x8 bits. In the RAM all the calibration values are stored and also the preset values for each function. A battery G1719 supplies the RAM if the power is switched off.

NOTE: To prevent loss of information during battery replacement, the latter can be done when the voltage at Tp1005 and Tp1007 is present.

2.5. DISPLAY

The OQ 0070 is a single chip silicon-gate C-MOS circuit, designed to drive a Liquid Crystal Display with up to 54 segments in a triplex manner. Reference voltages are internally generated with temperature compensation. A 2-line I²C bus structure enables serial data transfer with the microcomputer.

A LCD is an a.c. device. Therefore, for multiplexing the information of the segment line is important for each segment that will be driven by that line.

When triplexing (in the PM 2519) is used, each backplane is driven one third of a timeperiod. To ensure a longer lifetime, the driving pulse is inverted every time period.

The data derived from one data output is fed to three segments.

To these segments also one of the backplanes is supplied.

The voltage across a segment will determine if it is lit or not.

The following is an example.

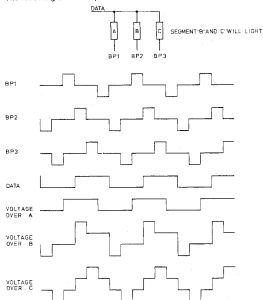

ST4416
840727

Fig. 2.17. Signals LCD drivers

2.6. POWER SUPPLY

The rectified voltage is fed to A1600 (pin 7) and also zener diode V1660. This gives a voltage of 2.7 V on the minus input of A1600 and gives a negative voltage on the output. Due to this, V1600 and V1601 start conducting. The voltage on the collector is fed back to the input and is now stabilized by zener diode V1662. Together with the voltage divider R1602 and R1604, it provides a voltage of +5 V on the collector of V1601. The +5 V is routed to a level converter which starts to oscillate. It converts the input voltage to -9 V and +9 V. The circuit is stabilized with the feed-back circuit consisting of zener diode V1671, V1670 supplied to V1605.

2.7. PM 2519/21

2.7.1. General

The PM 2519/21 version is a standard PM 2519 that includes a built-in battery power supply. The battery power supply part consists of one Pb cell and a circuit that converts the battery voltage into +5 V, +13 V and -13 V.

The circuit of the battery power supply can be subdivided into three main parts:

- Charging circuit

- Two level converters

- Schmitt trigger

As the battery pack is also used in the PM 2521, the level converters and the Schmitt trigger are not used for the PM 2519/21.

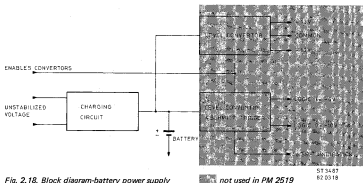

Fig. 2.18. Block diagram-battery power supply

2.7.2. Charging circuit (refer to the overall circuit Fig. 7.12)

If the battery is charged by the power supply (power switch in position "OFF"), PM 2519 connected to the mains, the voltage on point 2 of X9101 is stabilized by A9101. The output voltage of A9101 is the charging voltage for the battery.

When the temperature changes, the output voltage is compensated by V9101, so the required charging voltage is always available.

In the PM 2519, the converters are always disabled by means of two diodes V9202 and V9203. By this means, the battery is prevented from discharging via the converters.

NOTE: A PM 2519/01 in combination with a PM 9121 will convert the PM 2519/01 into a PM 2519/21.

2.8. PM 2519/51

2.8.1. IEC-625/IEEE-488 interface

An IEC-bus interface is used in multi-device systems to connect instruments in parallel to the same interface lines. Each instrument has its own specific address (selected with switches S0-S4 on the rear of the instrument). This addressing system means that an instrument is only listening or talking after it has received its specific address (MLA; my listen address, MTA; my talk address).

The listen or talk addresses are generated by the controller of the system (computer) and are transmitted via the data of the bus. During an address or interface message the ATN (attention) line is active to indicate that the information on the bus has a special interface function. The IEC-bus can be split up into three functional parts, the data bus, the handshake bus and the management bus.

- The data bus is used to transport messages for the device functions as well for the interface functions and consist of 8 lines (DI01-8).
- The handshake bus controls the correct transfer of data bytes with the next three signals. Data valid (DAV) indicates if the data is valid. Not Ready For Data (NRFD) indicates the condition of readiness of device(s) to accept data.
- Not Data Accepted (NDAC) indicates the condition of acceptance of data bytes by devices.
- The management bus is used to manage an orderly flow of information across the interface. For this purpose the next five signals are available:

Attention	Specifies how data on the D10 lines are to be interpreted. Active indicates a interface message is transferred via the data bus (for example a listen address), not active status is present during normal data transfer (for example a command for ranging).
Interface clear	IFC places the interface of all interconnected devices in the idle state.
Service request	SRQ indicates that one of the instruments wants the attention of the controller for example to indicate that there is valid data.
Remote enable	REN sets an instrument to its remote-control mode if it is in the addressed state.
End of Identify	EOI indicates the end of a multiple byte transfer.

When the PM 2519/51 is switched on, the microcomputer reads the switches to identify the mode of the interface, Listen-only, Talk-only or Addressable mode. After this it sets the interface in a condition to input data.

Receiving

First the system controller sends a listen address (MLA) via the D10 lines (ATN is true). Due to ATN is true D604 and D603 are switched to receive direction.

Also via the hardware, NDAC is generated. The TA (talker active) signal is high so that the input of D602 (a special GPIB device) is low. This means that a part of D602 acts as input and another part as output.

D602	{ Outputs: NDAC, NRFD, SRQ { Inputs : DAV, REN, ATN, EOI, IFC
------	--

Also after ATN, the microcomputer reads the selected device address by making pin 10 of D605 low and input 19 of D604 high (high impedance). Then the microcomputer starts handshaking the device address on the bus. This is controlled via P1 of the microcomputer. If the device address on the bus is the same as the device address selected with the switches, the microcomputer starts to handshake in the other data bytes.

Transmitting

After the microcomputer has received MTA (or in Talk-only mode) as described above, the interface becomes talker. This means that D604 and D603 are now transmitters. The bytes on P0 are now data for the controller. If the interface becomes talker it makes P13 low. The GPIB device D602 is switched to another configuration.

D602	}	Outputs: DAV, SRQ, EOI
	}	Inputs: : NDAC, NRFD, REN, ATN, IFC

The PM 2519/51 is now handshaking so that the bytes are sent to a controller or another device. At the end of the databytes the PM 2519/51 generates an EOI. The interface will remain talker until the Listener address is again on the bus or after an IFC command connected to the interrupt system of the interface.

3. CHECKING AND ADJUSTING

WARNING: Before switching-on, ensure that the instrument has been installed in accordance with the instructions outlined in Section 4 of the Operating Manual.

The opening of covers or removal of parts, except those to which access can be gained by hand is likely to expose live parts, and accessible terminals may also be live.

The instrument shall be disconnected from all voltage sources before any replacement or maintenance and repair during which the instrument will be opened.

If afterwards, any adjustment, maintenance or repair of the opened instrument under voltage conditions is inevitable, it shall be carried out only by a skilled person who is aware of the hazard involved.

Bear in mind that capacitors inside the instrument may still be charged even if the instrument is separated from all voltage sources.

The tolerances in this chapter correspond to the factory data, which only apply to a completely re-adjusted instrument. These tolerances may deviate from those mentioned in the Technical Data. (Chapter 1 of the Service Manual).

For a complete re-adjustment of the instrument the sequence in this chapter should be adhered to. When individual components, especially semi-conductors are replaced, the relevant section should be completely re-adjusted.

To calibrate this measuring instrument, only reference voltages and measuring equipment with the required accuracy should be applied. If such equipment is not available, comparative measurements can be made with another calibrated PM 2519. However, theoretically in extreme cases, the tolerances may leave some room for doubt.

The measuring arrangement should be such that the measurement cannot be affected by external influences. Protect the circuit against temperature variations (fans, sun).

With all measurements, the cables should be kept as short as possible; at higher frequencies co-axial leads should be used.

Non screened measuring cables may act as aerials so that the measuring instrument could measure LF voltage values or hum voltage.

3.1. GENERAL

ATTENTION: Before checking and adjusting, the PRESET values, which are stored in RAM must be reset. To do this, shortcircuit Tp1001 and Tp1002, for one second in position \Rightarrow \square $< 10\Omega$.
If the instrument is closed, shortcircuit spots via hole 2 and 5 in position \Rightarrow \square $< 10\Omega$.

The adjusting procedure consists of two parts: A and B. The first part (A) and the second part (B) of the procedure only should be used when the OO 0063 or the OO 0068 have been replaced. In all other cases it is possible to start direct with part B. If a calibration cannot be made it is recommended to start first with part A.

If the software there are subroutines which are used to adjust the PM 2519. To call these subroutines short-circuit TP1001 and TP1002 for one second in position Hz, if the instrument is opened.

If only calibration part B must be done, it is not necessary to open the instrument. In the bottom there are 8 holes. Short circuiting the spots via hole 2 and 5, will bring up the calibration mode. This must be done in the position Hz.

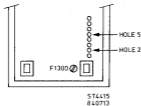

Fig. 3.1. Bottom cover

NOTE: For instruments with a serial no. lower than DY01 3611, resetting the PRESET values and entering the calibration mode is done via hole 2 and 4 (teflon holes).

When the calibration mode is entered the instrument will respond with 1000.c kHz. The other calibration routines can be selected with the function switch and the up/down buttons (see calibration procedure). To calibrate the range, supply the displayed signal to the input terminals, and push the ZERO SET ON/OFF knob. The PM 2519 will respond with e.g. 100.0r mV. If the supplied signal is not the right one the PM 2519 will respond with 100.0F mV or if the input signal is unstable the PM 2519 responds with 100.0u mV.

If a range is selected which cannot be calibrated while pushing the ZERO SET ON/OFF button the PM 2519 will respond with Err.

After using these subroutines the PM 2519 should be reset (switch the PM 2519 off and on).

3.2. ADJUSTING THE PM 2519 WITH THE AID OF A CONTROLLER (for PM 2519/51 only)

The calibration mode can be called via the IEC-bus. To use this feature, a program string must be sent to the PM 2519. It is device programming, so the message consists of a header, a body and a separator.



On receipt of a character which is equivalent to decimal 195, on most controllers programmed as CHR\$(195), the calibration mode is entered. The same effect is afforded when short-circuiting TP1001 and TP1002 in the manual mode.

The body (range) is a decimal character which selects the range to be calibrated (see table). After entering the calibration mode, an execute command (X1 or GET) must be given. This has to be done before a new listen address is sent otherwise the calibration mode will be left.
Example: To calibrate the 100 mV range CHR\$(195)+"1X1" must be sent.

FUNCTION \ RANGE	1	2	3
mV~	100 mV	10 V	100 V
V~	1 V		
A~	20 mA		
A~	2 A*		
Ohm	20 mA		
°C	1000 ohm		
V~	0 °C	10 V	
	-		

* lead in A-bus

If the calibration mode is entered, the output data is e.g. VDC 100.00 mV. A range is calibrated, when the PM 2519/51 will respond in his output data with e.g. VDC 100.0r mV. If the supplied signal is not the right one the PM 2519/51 responds with VDC 100.0F mV or if the supplied signal is unstable it responds with 100.0u mV. If a range has been selected, which does not need to be calibrated the PM 2519/51 does not give output data!

Program example on P2000C

```
10 IEC INIT
20 PRINT "Select mV function and supply 100 mV"
30 IEC PRINT #22, CHR$(195) + "1X1": REM enter calibration mode, range 1 and execute
40 IEC END
```

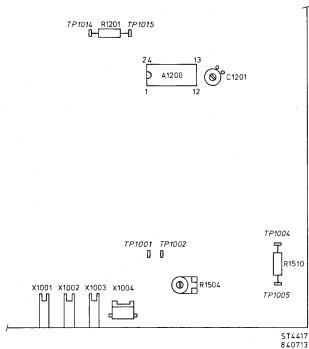
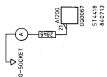

Fig. 3.2. Adjusting elements

3.3. PART A

No.	Adjustment	Adjusting element	Preparations	Input signals	Adjusting data	Measuring points
1.	Reference current of current source of ADC (000067)	Resistor R1201; (MR25, 1% E96 series)	Set instrument in position V _{ref} . Select: AUTO ranging. Connect an Ammeter as follows: 		140 μA measured with an Ammeter ± 0.5%	A1200 point 21 and 0-socket
2.	Reference current of current source (000065)	Resistor R1510 (MR25, 1% E96 series)	Set instrument in position Ω. Select: MAN ranging. 1000 Ω range. Connect an Ammeter to the 0 and V-Ω mA socket		1 mA measured with an Ammeter ± 0.5%	0 and V-Ω mA socket
3.	Zero setting	Trimming capacitor C1201	Set instrument in position V _{ref} . Select: AUTO ranging	Short circuit the V-Ω mA and the 0 socket	.0000 V ± 0 dig.	Display

NOTE: Input signals have to be connected to the V-Ω mA- and 0 socket, unless otherwise stated.

No.	Adjustment	Adjusting element	Preparation	Input signals	Adjusting data	Remarks
4.	Ω ranges		Set instrument in Hz Short-circuit TP1001 and TP1002 for one second. Set instrument in mV $\overline{\text{---}}$			
5.	1000 Ω range 10 M Ω range	— Resistor R1504	Set instrument in Ω Select: 1000 Ω range Switch instrument off and on Set instrument in position Ω Select: MAN ranging 10 M Ω range	1000 $\Omega \pm 0.1\%$ 10 M $\Omega \pm 0.1\%$	1000r Ω 10.000 M Ω	Press ZERO SET ON/OFF Display

3.4. PART B

No.	Adjustment	Adjusting element	Preparation	Input signals	Adjusting data	Remarks
1.	DC ranges 100 mV range	—	Set instrument in Hz Short-circuit the spots via hole 2 and 5 (see Fig. 3.1.) for one second. Set instrument in mV_{max}	$+100 \text{ mV} \pm 0.01\%$	$+100.0 \text{ r mV}$	Press ZERO SET ON/OFF
2.	1 V range	—	Set instrument in V_{max} Select: 1 V range	$+1 \text{ V} \pm 0.01\%$	$+1.000 \text{ r V}$	Press ZERO SET ON/OFF
3.	10 V range	—	Set instrument in V_{max} Select: 10 V range	$+10 \text{ V} \pm 0.01\%$	$+10.00 \text{ r V}$	Press ZERO SET ON/OFF
4.	100 V range	—	Set instrument in V_{max} Select: 100 V range	$+100 \text{ V} \pm 0.01\%$	$+100.0 \text{ r V}$	Press ZERO SET ON/OFF
5.	A_{max} ranges 20 mA range	—	Set instrument in A_{max} Select: 20 mA range	$+20 \text{ mA} \pm 0.05\%$	$+20.0 \text{ r mA}$	Press ZERO SET ON/OFF
6.	2 A range	—	Set instrument in A_{max} Select: 2 A range	$+2 \text{ A} \pm 0.05\%$ supplied to A and 0 socket	$+2.00 \text{ r A}$	Press ZERO SET ON/OFF
7.	A_{\sim} ranges 20 mA range	—	Set instrument in A_{\sim} Select: 20 mA range	$\sim 2 \text{ A } 1 \text{ kHz} \pm 0.05\%$	$\sim 20.0 \text{ r mA}$	Press ZERO SET ON/OFF
8.	Ω ranges 1000 Ω range	—	Set instrument in Ω Select: 1000 Ω range	$1000 \Omega \pm 0.1\%$	$1000. \text{ r } \Omega$	Press ZERO SET ON/OFF

No.	Adjustment	Adjusting element	Preparation	Input signals	Adjusting data	Remarks
9.	$^{\circ}\text{C}$ range 0°C calibration		Set instrument in $^{\circ}\text{C}$	$100\ \Omega \pm 0.1\%$ to the PROBE input 	000 r $^{\circ}\text{C}$	Press ZERO SET ON/OFF
10.	$\text{V}\sim$ ranges 10 V range	—	Set instrument in $\text{V}\sim$ Select: 10 V range	$\sim 10\ \text{V}\ 60\ \text{Hz} \pm 0.01\%$ supplied to $\text{V}\sim\Omega$ mA and 0 socket.	$\sim 10.00\ \text{r V}$	Press ZERO SET ON/OFF
11.	—	—	Switch instrument off and on	—	—	—

No.	Checks		Preparations	Input signals	Adjusting data	Measuring points
12.	V \sim range		Set instrument in V \sim Select: MAN ranging : 1 V range Select: 10 V range : dB (R _{ref} = 600 Ω) : Press ZERO SET ON/OFF	0 mV ~ 1 V 60 Hz \pm 0.05% ~ 200 mV 500 Hz \pm 0.05% ~ 1 V 500 Hz \pm 0.05% ~ 1 V 10 kHz \pm 0.05% ~ 1 V 20 kHz \pm 0.05% ~ 10 V 60 Hz \pm 0.05% ~ 10 V 60 Hz \pm 0.05%	~ 0.0000 V \pm 0 dig. ~ 1.0000 V \pm 48 dig. ~ 0.2000 V \pm 12 dig. ~ 1.0000 V \pm 48 dig. ~ 1.0000 V \pm 88 dig. ~ 1.0000 V \pm 440 dig. ~ 022.2 dB \pm 1 dig. ~ 000.0 dB \pm 1 dig.	Display

No.	Checks	Preparations	Input signals	Adjusting data	Measuring points
		: Press dB/V : 100 V range : 1000 V range	~ 10 V 60 Hz $\pm 0.05\%$ ~ 10 V 500 Hz $\pm 0.05\%$ ~ 10 V 20 kHz $\pm 0.05\%$ ~ 100 V 60 Hz $\pm 0.05\%$ ~ 100 V 500 Hz $\pm 0.05\%$ ~ 100 V 10 kHz $\pm 0.05\%$ ~ 100 V 20 kHz $\pm 0.05\%$ ~ 220 V 60 Hz $\pm 0.05\%$ ~ 800 V 60 Hz $\pm 0.05\%$	~ 10.000 V ± 10 dig. ~ 10.000 V ± 48 dig. ~ 10.000 V ± 440 dig. ~ 100.00 V ± 48 dig. ~ 100.00 V ± 48 dig. ~ 100.00 V ± 88 dig. ~ 100.00 V ± 440 dig. ~ 220.0 V ± 17 dig. ~ 800.0 V ± 32 dig.	Display
13.	V _{max} ranges	Set instrument in V _{max} Select: MAN ranging : 100 mV range : 1 V range : 10 V range : 100 V range : 1000 V range	+100 mV $\pm 0.01\%$ +1 V $\pm 0.01\%$ -1 V $\pm 0.01\%$ +300 mV $\pm 0.01\%$ +10 V $\pm 0.01\%$ -10 V $\pm 0.01\%$ +100 V $\pm 0.01\%$ +1000 V $\pm 0.01\%$	+100.00 V ± 5 dig. +1.0000 V ± 5 dig. -1.0000 V ± 10 dig. +.3000 V ± 4 dig. +10.000 V ± 5 dig. -10.000 V ± 10 dig. +100.00 V ± 5 dig. +1000.0 V ± 10 dig.	Display
14.	Check V _{max} , \blacksquare > preset	Set instrument in V _{max} , \blacksquare > preset Select: Preset value of 10 V	+10.5 V $\pm 0.01\%$	10.500 V ± 10 dig.	Audible tone
15.	Check A _{max} ranges	Set instrument in A _{max} Select: MAN ranging : 20 mA : 200 mA : 2 A : 20 A	~ 20 mA 60 Hz $\pm 0.05\%$ ~ 200 mA 60 Hz $\pm 0.05\%$ ~ 2 A 60 Hz $\pm 0.05\%$ ~ 10 A 60 Hz $\pm 0.05\%$	~ 20.00 mA ± 14 dig. ~ 200.0 mA ± 14 dig. ~ 2.000 A ± 14 dig. ~ 10.00 A ± 14 dig.	Display

No.	Checks	Preparations	Input signals	Adjusting data	Measuring point
16.	Check A_{max} range	Set instrument in A_{max} Select: MAIN ranging : 20 mA : 200 mA : 2 A	+20 mA \pm 0.05% +200 mA \pm 0.05% +2 A \pm 0.05%	+20.00 mA \pm 5 dig. +200.0 mA \pm 10 dig. +2.000 A \pm 5 dig.	Display
NOTE: The high current ranges (0.2 - 20 A) are selected by connecting the leads between the D-socket and the 0.2 - 10 A socket and the UP/DOWN buttons.					
17.	Check Ω ranges	Set instrument in Ω Select: MAIN ranging : 1000 Ω range : 10 k Ω range : 100 k Ω range : 1000 k Ω range : 10 M Ω range	1000 Ω \pm 0.1% 10 k Ω \pm 0.1% 100 k Ω \pm 0.1% 1000 k Ω \pm 0.1% 10 M Ω \pm 0.1%	1000.0 Ω \pm 20 dig. 10.000 k Ω \pm 32 dig. 100.00 k Ω \pm 32 dig. 1000.0 k Ω \pm 48 dig. 10.000 M Ω \pm 48 dig.	Display
18.	Check \rightarrow \square < 10 Ω	Set instrument in \rightarrow \square < 10 Ω	1000 Ω \pm 0.1%	1000.0 mV \pm 100 dig.	
19.	$^{\circ}\text{C}$	Set instrument in $^{\circ}\text{C}$	100 Ω \pm 0.1% to the PROBE input	100.0 \pm 10 dig.	Display
					
20.	Check Hz ranges	Set instrument in Hz Select: MAIN ranging : 10 kHz range : 100 kHz range : 1 MHz range	(3 V) 10 kHz \pm 0.01% (3 V) 100 kHz \pm 0.01% (3 V) 1 MHz \pm 0.01%	10.000 kHz \pm 3 dig. 100.00 kHz \pm 3 dig. 1.0000 MHz \pm 3 dig.	Display

3.5. ADJUSTING THE BATTERY POWER SUPPLY PM 2519/21

- Disconnect the battery power supply from the PM 2519/21.
- Remove the battery.
- In its place, fit a $1\text{ k}\Omega$ resistor across the battery terminals of the power supply unit.
- Connect a voltage of +10 V (20 mA) across point 10(+) and 8(-) of the printed circuit board.
- With the preset R105, adjust the voltage across the external $1\text{ k}\Omega$ resistor to 6.9 V.
- Connect the PM 2519/21 to the mains and check if the charging current is between 5 mA and 400 mA. (Insert an Ammeter in series with the battery, range 1 A).

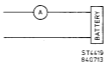
ST4479
840713

4. FAULT-FINDING

WARNING: The opening of covers or removal parts, except those to which access can be gained by hand is likely to expose live parts, and accessible terminals may also be live.

The instrument shall be disconnected from all voltage sources before any replacement or maintenance and repair during which the instrument will be opened.

If afterwards, any adjustment, maintenance or repair of the opened instrument under voltage conditions is inevitable, it shall be carried out only by a skilled person who is aware of the hazard involved.

Bear in mind that capacitors inside the instrument may still be charged even if the instrument is separated from all voltage sources.

4.1. GENERAL

4.1.1. Service hints

If servicing is necessary the following points should be taken into account in order to avoid damaging the instrument.

- Take care to avoid short-circuits with measuring clips and hooks if the instrument is switched-on, especially near the input terminals when high-voltages are present.
- Use a miniature soldering iron (35 W max.) with a thin cleaner or a vacuum soldering iron.
- Use an acid-free solder.
- When fault-finding, remove top and bottom covers and connect an external power supply of +7 V to TP1005 (+) and TP1007 (-).
- After repair, the instrument should be recalibrated.

4.1.2. Fault-finding procedure

This chapter gives a fault-finding procedure to locate the faulty section in the instrument. From this procedure the faulty parts can often be found by using the detailed flow-charts.

NOTE: *The procedure is only intended as an aid to fault-finding, and obviously the faulty component will not be found in every case.*

Measuring instruments used:

- Digital multimeter
- Oscilloscope
- Counter
- Signature analyser

After repair, the preset values, which are stored in RAM, must be reset. To do this short-circuit TP1001 and TP1002 for one second in the position →

4.2. FAULT-FINDING FLOW-CHARTS

4.2.1. Initial test

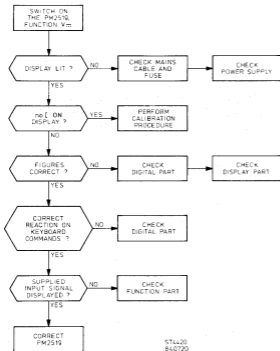

4.2.2. Function part test

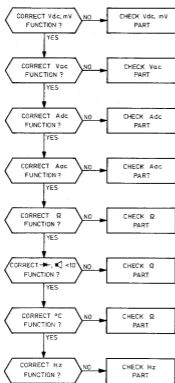
ST4421
840629

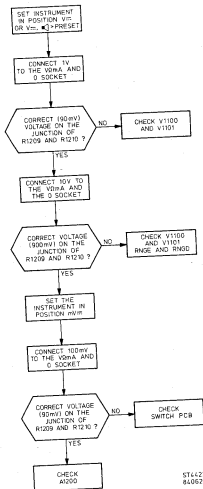
4.2.3. Vdc, mV and  > preset part test

NOTE: The voltage on the junctions must be measured with a high impedance voltmeter (100 MΩ). If this is not possible take account of the shunting effect (input impedance PM 2519).

RANGE	ATTN.	SENS. ADC	RNG D	RNG E
100 mV	1,1	90 mV	0	0
1 V	11,11	90 mV	0	0
10 V	11,11	900 mV	0	1
100 V	1111,11	90 mV	1	0
1000 V	1111,11	900 mV	1	1

1 = 0 V
0 = -9 V

ST4422
840629

NOTE: Measurement zero is the low socket.

4.2.4. Vac part test

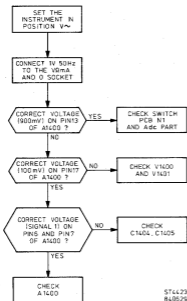
ST4423
840529

NOTE: The voltage on pin 17 must be measured with a high impedance voltmeter (100 MΩ). If this is not possible take account of the shunting effect (input impedance PM 2519).

Signal 1 pin 6 and 7 of the RMS converter.

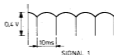

0 = -9 V
1 = 0 V

RANGE	ATTN	SENS. RMS	RNG F	RNG G
1 V	10	100 mV	0	0
10 V	10	1000 mV	0	1
100 V	1000	100 mV	1	0
1000 V	1000	1000 mV	1	1

NOTE: Input sensitivity ADC 900 mV.
Measurement zero is the low socket.

4.2.5. Adc part test

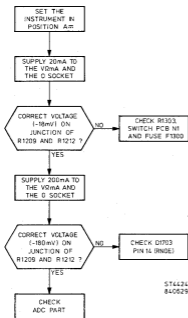

RANGE	SENS. ADC	RNG E
20 mA	18 mV	0
200 mA	180 mV	1

0 = -9 V

1 = 0 V

NOTE: Measurement zero is the low socket.

4.2.6. Aac part test

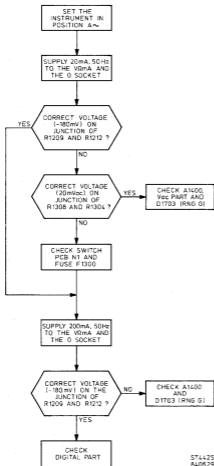

RANGE	SENS. RMS	RNG E
20 mA	18 mV	0
200 mA	180 mV	1

0 = -9 V

1 = 0 V

ST4425
840529

NOTE: Measurement zero is the low socket.

4.2.7. Ohm part test

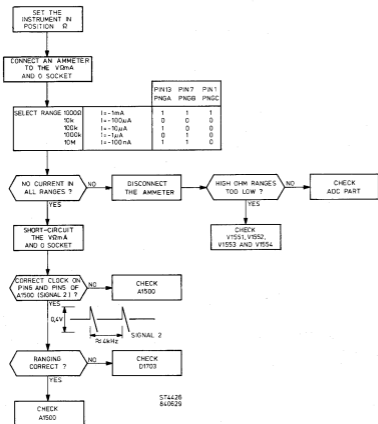

NOTE: Measurement zero is the low socket.

4.2.8. Hz part test

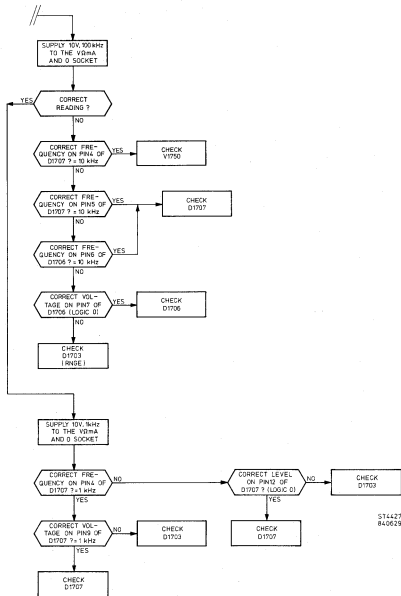
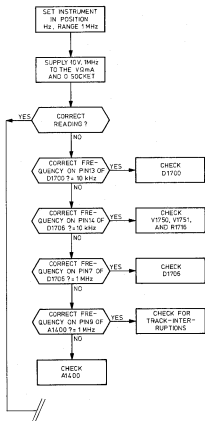
514427
84-0629

NOTE: Measurement zero is the low socket.

4.2.9. ADC part test

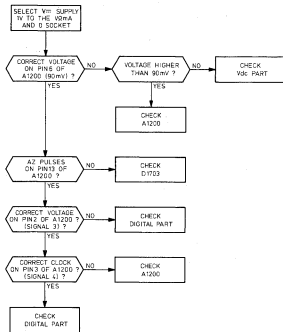

NOTE: Measurement zero is the low socket.

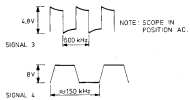

ST4428
840629

4.2.10. Digital part test

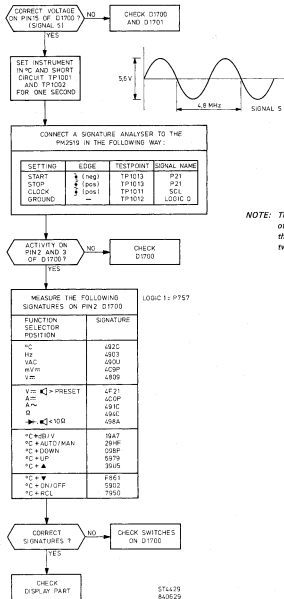

4.2.11. Display part test

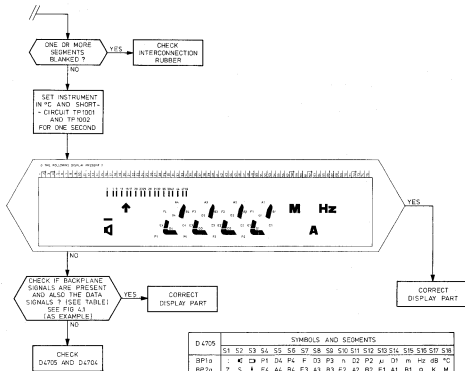
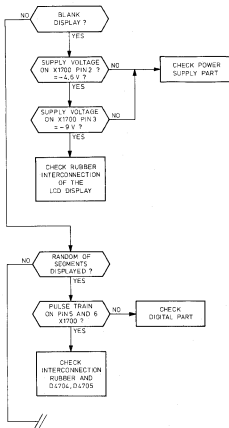

D 470S	SYMBOLS AND SEGMENTS																		
	S1	S2	S3	S4	S5	S6	S7	S8	S9	S10	S11	S12	S13	S14	S15	S16	S17	S18	
BP1a	:	∞	□	P1	Q4	P4	F	Q3	P3	n	D2	P2	μ	D1	m	H2	dB	°C	
BP2a	2	S	↑	F4	A4	B4	F3	A3	B3	F2	A2	B2	F1	A1	B1	Q	K	M	
BP3a	~	~	~	E5	F4	G4	C4	E3	G3	C3	E2	G2	C2	E1	D1	C1	mIA	A	V
D470L	BARGRAPH NUMBERS AND SYMBOLS																		
	X1	X2	X3	X4	X5	X6	X7	X8	X9	X10	X11	X12	X13	X14	X15	X16	X17	X18	
BP1b	0	5	6	E	X1	13	14	∞	21	22	∞B	29	30	37	38	40	45	46	
BP2b	1	4	7	9	12	15	17	20	23	25	28	31	33	36	39	41	44	47	
BP3b	2	3	8	10	11	16	18	19	24	26	27	32	34	35	42	43	48		

ST4430
840713

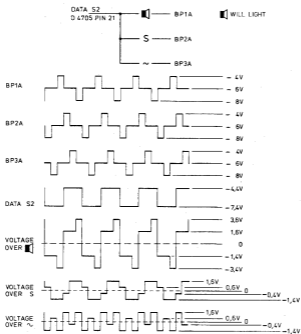
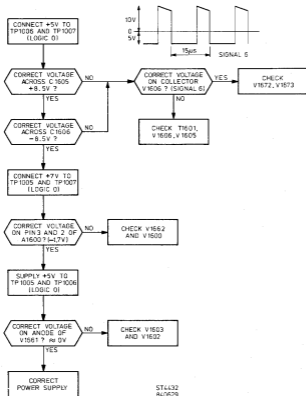

Fig. 4.1. Signals LCD

ST4431
B40727

4.2.12. Power supply test



NOTE: Measurement zero is the low socket.

4.2.13. Galvanic separation test (PM 2519/51)

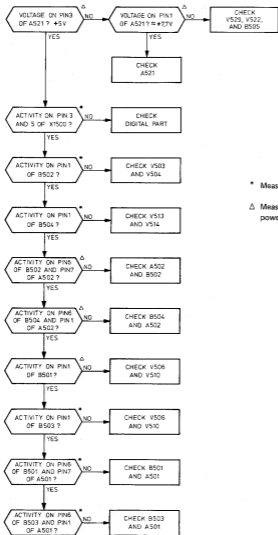

* Measurement zero is the low socket.

Δ Measurement zero is the zero of the power supply on the galvanic separation.

ST4433
840529

ST4433
840529

4.2.14. IEC-bus test (PM 2519/51)

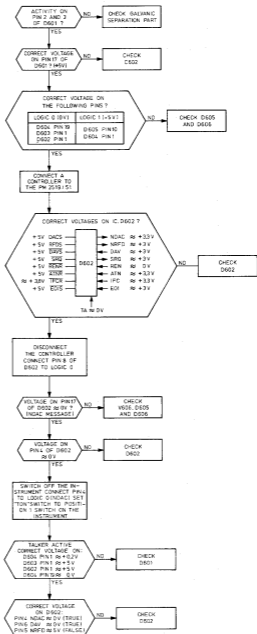

Measurement zero is the zero of the power supply of the galvanic separation p.c.b.

5. ACCESS

WARNING: The opening of covers or removal of parts, except those to which access can be gained by hand is likely to expose live parts, and accessible terminals may also be live.

The instrument shall be disconnected from all voltage sources before any replacement or maintenance and repair during which the instrument will be opened.

If afterwards, any adjustment, maintenance or repair of the opened instrument under voltage conditions is inevitable, it shall be carried out only by a skilled person who is aware of the hazard involved.

Bear in mind that capacitors inside the instrument may still be charged even if the instrument is separated from all voltage sources.

5.1. DISMANTLING THE PM 2519

Removing the top cover (Fig. 5.1.)

- Place the hand in its bottom position.
- Remove the two fixing screws at the rear which attach the top cover to the bottom cover.
- Lever the top cover and pull it backwards.
- Disconnect the mains plugs which are connected to the p.c.b.

Removing the bottom cover (Fig. 5.2.)

- Remove the top cover.
- Remove the handle.
- Remove the three fixing screws which attach the printed circuit board to the bottom cover (Fig. 5.2. item 1)
- Bend out the two hooks of the front plate (Fig. 5.2. item 2).
- Remove the bottom cover.

Removing the front assembly

- Remove top and bottom cover.
- Disconnect the flexible print from the connector X1700 (Fig. 5.2. item 3).
- Disconnect X1702 (Fig. 5.2. item 4).
- Bend out the two hooks of the front plate at the bottom of the printed-circuit board (Fig. 5.3. item 1).
- Disconnect the front from the printed circuit board.

REPLACING PARTS

Liquid crystal display (Fig. 5.4. item 1), display unit N4 (Fig. 5.4. item 2), interconnection rubber (Fig. 5.4. item 3) or function knob (Fig. 5.4. item 4).

- Remove the front assembly.
- Remove the three screws which attach N3 to the front (Fig. 5.4. item 5).
- Remove the three screws of the screening.
- Remove the function knob by bending out the four hooks of the front plate (only for replacing the function knob) (Fig. 5.4. item 8).
- Remove the three screws from the display unit cover and the cover itself (Fig. 5.4. item 9).
- Replace the defective component and mount the L.C.D. unit again as described above.

NOTE 1: Make sure that the L.C.D., the display unit cover and the interconnection rubber are placed in the most right hand position (Fig. 5.4. item 7).

NOTE 2: Do not touch the contacts of the L.C.D., the interconnection rubber and the display unit N4 with the fingers.

Function switch (Fig. 5.4)

- Remove the top- and bottom cover. Remove also the front assembly.
- Bend out the two hooks and remove the printed-circuit board (Fig. 5.4. item 6).
- The function switch consist of:
 - 2 slide bodies
 - 4 springs
 - 4 switch contacts
- Remove the screws and nuts from the slide bodies. The bodies can now be lifted from the printed-circuit board.

NOTE: The slide body is stocked complete with springs and switch contacts.

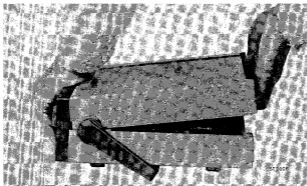

Fig. 5.1. Removing the top cover

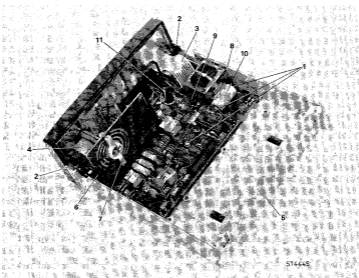
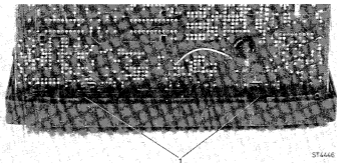
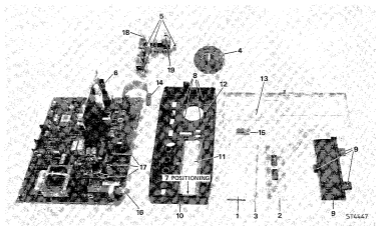

Fig. 5.2. Removing the bottom cover



ST4446

Fig. 5.3. Removing the front



ST4447

Fig. 5.4. Front assembly

5.2. DISMANTLING THE BATTERY POWER SUPPLY (PM 2519/21)

- Remove the top cover as described.
- Disconnect the connector from X1600.
- Remove the two screws from the battery power supply cover (Fig. 5.5, item 1).
- Lever up the cover and remove it.
- Remove the two screws (Fig. 5.5, item 2).
- The battery and the printed-circuit board can now be removed.

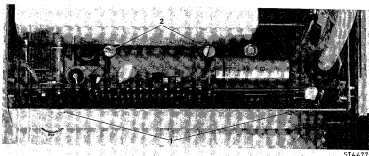

Fig. 5.5. Dismantling the battery power supply

5.3. DISMANTLING THE IEC-BUS AND THE GALVANIC SEPARATION (PM 2519/51)

Dismantling the IEC-bus

- Remove the two screws (Fig. 5.6. item 1).
- Remove the connector X602.
- The IEC-bus can now be removed.
- Remove the screening of the IEC bus.

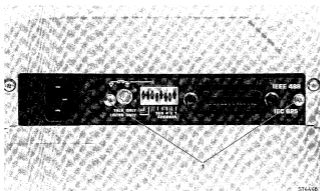

Fig. 5.6. IEC-bus

Dismantling the galvanic separation

- Remove the top cover.
- Unfasten the four screws to remove the screening.
- Unfasten the four screws that attach the galvanic separation to the top cover.
- Remove the two plugs of the main connector, which are connected to the p.c.b.

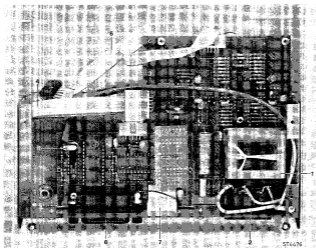

Fig. 5.7. Galvanic separation and IEC-bus

6. PARTS LIST

6.1. MAIN P.C.B.

6.1.1. Resistors

<i>Pos. nr.</i>	<i>Description</i>			<i>Ordering code</i>
R1100	MR30	0.5%	51K1	5322 116 55577
R1101	MR30	0.5%	48K7	5322 116 51388
R1102		0.25%	4M53	5322 116 52126
R1103		0.25%	4M53	5322 116 52126
R1104	MR25	1%	100K	4822 116 51268
R1105			10K	4822 116 51253
R1107	MR25	1%	100E	5322 116 55549
R1108		0.1%	7K57	5322 116 52118
R1109	MR25	1%	75K	4822 116 51267
R1110	MR30	0.5%	100K	5322 116 52125
R1200		0.1%	8K76	5322 116 52117
R1205	MR25	0.5%	1K15	5322 116 52121
R1206	MR25	1%	30E1	5322 116 50904
R1209		0.1%	825K	5322 116 52119
R1210		0.1%	825K	5322 116 52119
R1211	MR25	1%	1K78	5322 116 50615
R1216	MR25	1%	17K8	5322 116 54637
R1300		10%	50E	4822 116 30008
R1301		1%	1E	5322 113 21004
R1303	MR25	1%	110K	5322 116 54701
R1304	MR25	1%	3K32	4822 116 51247
R1305	MR25	1%	100K	4822 116 51268
R1306	MR25	1%	20K5	5322 116 55419
R1308	MR25	1%	205K	5322 116 54727
R1400	MR30	0.5%	909K	5322 116 55211
R1401	MR30	0.5%	887K	5322 116 55285
R1402	MR25	1%	38E3	5322 116 50954
R1403		0.1%	1K78	5322 116 51776
R1404		0.1%	200K	5322 116 51773
R1405		0.1%	3K01	5322 116 51777
R1406	MR25	1%	33E2	5322 116 50527
R1407		0.1%	30K1	5322 116 51781
R1408	MR25	1%	6K81	4822 116 51252
R1411	MR25	1%	6K81	4822 116 51252
R1500	PTC		750 ÷ 1K5	5322 116 44006
R1501	PTC		750 ÷ 1K5	5322 116 44006
R1502	MR25	1%	10K	4822 116 51253
R1503	MR25	0.5%	2K87	5322 116 55279
R1504		Carb. lin.	100E	4822 100 10075
R1505	MR25	0.5%	2K87	5322 116 55279
R1506	VR25	1%	10M	5322 116 51788
R1508	MR25	1%	100E	5322 116 55549
R1511		0.1%	16K9	5322 116 52116
R1512		0.1%	121K	5322 116 51774
R1513	MR25	1%	100K	4822 116 51268

<i>Pos. nr.</i>	<i>Description</i>			<i>Ordering code</i>
R1514	MR25	1%	226K	5322 116 54729
R1600	PR37	5%	15E	4822 116 51144
R1602	MR25	0.5%	1K87	5322 116 52123
R1603	MR25	1%	1M	5322 116 55535
R1604	MR25	1%	3K65	5322 116 54567
R1605	MR25	1%	348E	5322 116 54515
R1606	MR25	1%	51K1	5322 116 50672
R1607	MR25	1%	953K	5322 116 51368
R1608	MR25	1%	10K	4822 116 51253
R1609	MR25	1%	1K27	5322 116 50555
R1610	MR25	0.5%	1K78	5322 116 52122
R1611	MR25	1%	3K48	5322 116 55367
R1612	MR25	0.5%	3K65	5322 116 52124
R1613	MR25	1%	100K	4822 116 51268
R1650	MR25	1%	2K26	5322 116 50675
R1651	MR25	1%	536K	5322 116 54758
R1653	MR25	1%	10E	5322 116 50452
R1700	MR25	1%	1M	5322 116 55535
R1701	MR25	1%	1K	4822 116 51235
R1704	MR25	1%	10K	4822 116 51253
R1705	MR25	1%	100E	5322 116 55549
R1706	MR25	1%	100E	5322 116 55549
R1707	MR25	1%	5K11	5322 116 54595
R1708	MR25	1%	90K9	5322 116 54694
R1709	MR25	1%	1M	5322 116 55535
R1710	MR25	1%	5K11	5322 116 54595
R1711	MR25	1%	90K9	5322 116 54694
R1712	MR25	1%	1M	5322 116 55535
R1713	MR25	1%	100E	5322 116 55549
R1714	MR25	1%	100E	5322 116 55549
R1715	MR25	1%	10K	4822 116 51253
R1716	MR25	1%	5K11	5322 116 54595
R1717	MR25	1%	10E	5322 116 50452
R1718	MR25	1%	100K	4822 116 51268
R1719	MR25	1%	1K	4822 116 51235
R3800	51K1	1%	0.4W	5322 116 50672
R3801	51K1	1%	0.4W	5322 116 50672
R3802	51K1	1%	0.4W	5322 116 50672
R3803	51K1	1%	0.4W	5322 116 50672
R3804	51K1	1%	0.4W	5322 116 50672
R3805	51K1	1%	0.4W	5322 116 50672
R3806	51K1	1%	0.4W	5322 116 50672

6.1.2. Capacitors

<i>Pos. nr.</i>	<i>Description</i>			<i>Ordering code</i>
C1100	250V	10%	68NF	5322 121 44137
C1101	100V	10%	220NF	4822 121 40232
C1102	630V	1%	9.53NF	5322 121 50923
C1103	400V	10%	33NF	5322 121 44025
C1104		-20+50%	10NF	4822 122 31414

<i>Pos. nr.</i>	<i>Description</i>			<i>Ordering code</i>
C1105		-20+50%	10NF	4822 122 31414
C1201	250V		1.4/10PF	4822 125 50052
C1203	250V	10%	47NF	5322 121 44138
C1204		2%	390PF	4822 122 31426
C1205		2%	390PF	4822 122 31426
C1206		2%	47PF	4822 122 31244
C1207			3.9PF	5322 122 34107
C1208		-20+50%	10NF	4822 122 31414
C1209		-20+50%	10NF	4822 122 31414
C1210		-20+50%	10NF	4822 122 31414
C1211		-20+50%	10NF	4822 122 31414
C1212		-20+50%	10NF	4822 122 31414
C1213		2%	47PF	4822 122 31244
C1214		2%	39PF	5322 122 32047
C1215		2%	39PF	5322 122 32047
C1302		10%	2.7NF	4822 122 31174
C1400	400V	10%	33NF	5322 121 44025
C1401			3.9PF	4822 122 31217
C1402			3.9PF	4822 122 31217
C1403	100V	10%	1.8NF	4822 122 30048
C1404		2%	100PF	4822 122 31504
C1405	10V	20%	15UF	5322 124 14036
C1406	100V	10%	680NF	5322 121 40233
C1407		-20+50%	10NF	4822 122 31414
C1408		-20+50%	10NF	4822 122 31414
C1409	100V	10%	1UF	5322 121 40197
C1410		-20+50%	10NF	4822 122 31414
C1411		-20+50%	10NF	4822 122 31414
C1412		-20+50%	10NF	4822 122 31414
C1500	250V	10%	22NF	4822 121 41587
C1501		10%	4.7NF	4822 122 30128
C1502		10%	1NF	4822 122 30027
C1503		-20+50%	10NF	4822 122 31414
C1504		-20+50%	10NF	4822 122 31414
C1505		-20+50%	10NF	4822 122 31414
C1506	400V	10%	33NF	5322 121 44025
C1507	25V	20%	1UF	4822 124 20944
C1508		10%	1NF	4822 122 30027
C1509		-20+50%	10NF	4822 122 31414
C1600		-10+50%	330UF	4822 124 20705
C1601	10V	20%	10UF	5322 124 14066
C1602		-10+50%	330UF	4822 124 20684
C1603	25V	50%	22UF	4822 124 20698
C1604	25V	50%	22UF	4822 124 20698
C1605	25V	50%	22UF	4822 124 20698
C1608	10V	20%	10UF	5322 124 14066
C1609		-20+50%	10NF	4822 122 31414
C1610		2%	47PF	4822 122 31244
C1611		10%	1NF	4822 122 30027
C1612		10%	1NF	4822 122 30027
C1613		10%	1NF	4822 122 30027
C1614		10%	1NF	4822 122 30027
C1700		-20+50%	10NF	4822 122 31414
C1701		-20+50%	10NF	4822 122 31414
C1702		-20+50%	10NF	4822 122 31414

<i>Pos. nr.</i>	<i>Description</i>	<i>Ordering code</i>
C1703	-20+50% 10NF	4822 122 31414
C1704	-20+50% 10NF	4822 122 31414
C1705	-20+50% 10NF	4822 122 31414
C1706	-20+50% 10NF	4822 122 31414
C1707	-20+50% 10NF	4822 122 31414
C1708	-20+50% 10NF	4822 122 31414
C1709	-20+50% 10NF	4822 122 31414
C1710	2% 47PF	4822 122 31244
C1711	-20+50% 10NF	4822 122 31414
C1712	25V 20% 1UF	4822 124 20944
C1713	-20+50% 10NF	4822 122 31414
C1714	10% 2.2NF	4822 122 30114
C1715	-20+50% 10NF	4822 122 31414
C1716	-20+50% 10NF	4822 122 31414
C1717	10% 2.2NF	4822 122 30114
C1718	-20+50% 10NF	4822 122 31414
C1719	25V 20% 1UF	4822 124 20944
C1720	25V 40% 1UF	4822 124 20944

6.1.3. Semi-conductors

<i>Pos.nr.</i>	<i>Description</i>	<i>Ordering code</i>
V1100	BF256B	5322 130 44744
V1101	BF256B	5322 130 44744
V1350	BAW62	4822 130 30613
V1400	BF256B	5322 130 44744
V1401	BF256B	5322 130 44744
V1450	BAW62	4822 130 30613
V1451	BAW62	4822 130 30613
V1550	BZV85-C5V1	4822 130 31456
V1551	BAX12A	5322 130 34605
V1552	BAX12A	5322 130 34605
V1553	BZV46-C2V0	4822 130 31248
V1554	BAW62	4822 130 30613
V1600	BC638	4822 130 41087
V1601	BD140	4822 130 40824
V1602	BC547B	4822 130 40959
V1603	BC559B	4822 130 44358
V1605	BC559B	4822 130 44358
V1606	BC547B	4822 130 40959
V1651	BZV85-C18	5322 130 32212
V1652	BZV85-C18	5322 130 32212
V1653	BYV27-150	4822 130 31628
V1654	BYV27-150	4822 130 31628
V1655	BYV27-150	4822 130 31628
V1656	BYV27-150	4822 130 31628
V1657	BAW62	4822 130 30613
V1658	BAW62	4822 130 30613
V1660	BZX79-B3V3	5322 130 31504
V1661	BAW62	4822 130 30613
V1662	BZX79-B3V3	5322 130 31504
V1663	BRY39	5322 130 40482

<i>Pos. nr.</i>	<i>Description</i>	<i>Ordering code</i>
V1670	BAW62	4822 130 30613
V1671	BZX79-B10	4822 130 34297
V1672	BAW62	4822 130 30613
V1673	BAW62	4822 130 30613
V1674	BAW62	4822 130 30613
V1700	BC547B	4822 130 40959
V1750	BAW62	4822 130 30613
V1751	BAW62	4822 130 30613
V1752	BAW62	4822 130 30613
V1753	BAW62	4822 130 30613
V1754	BAW62	4822 130 30613
V1755	BAT85	4822 130 31983

6.1.4. Integrated circuits

<i>Pos. nr.</i>	<i>Description</i>	<i>Ordering code</i>
D1700	MAB8440/D021	5322 209 10565
D1701	HEF4520BD	4822 209 10276
D1702	HEF4001BD	4822 209 10246
D1703	OQ0071	5322 209 81901
D1706	HEF4518BD	4822 209 10275
D1707	HEF4011BF	4822 209 10247
D1708	PCD8571	4822 209 10427
D3800	HEF4532BD	4822 209 10278
D4704	OQ0070T	5322 209 81899
D4705	OQ0070T	5322 209 81899
A1200	OQ0067A	5322 209 81883
A1400	OQ0068A	5322 209 81884
A1500	OQ0063KA	5322 209 81898
A1600	μ A741CN	4822 209 80617

6.1.5. Miscellaneous

Top cover assembly

<i>Description</i>	<i>Ordering number</i>	<i>Qty</i>	<i>Item</i>	<i>Fig.</i>
Top cover assy	5322 447 70078	1	1	5.1.
Mains connector	5322 267 30434	1		
Cable mains connector to p.c.b.	5322 321 20854	1		

Bottom cover assembly

Cover with screening and feet	5322 447 70077	1	5	5.2.
Carrying handle	5322 498 54105	1	2	5.1.

Front assembly

Front	5322 447 70078	1	10	5.4.
Function selector	5322 414 40016	1	4	5.4.
Window	5322 381 10562	1	11	5.4.
L.C.D.	5322 130 90158	1	1	5.4.
Rubber connection	5322 290 84079	1	3	5.4.
Ball	4822 520 40044	1	12	5.4.
Display p.c.b.	5322 216 81847	1	2	5.4.

<i>Description</i>	<i>Ordering number</i>	<i>Qty</i>	<i>Item</i>	<i>Fig.</i>
Preset switch p.c.b.	5322 216 91844	1	5	5.4.
Buzzer	5322 280 10158	1	13	5.4.
Cable to switch p.c.b.	5322 321 20773	1	14	5.4.

Switch assembly

N2 printed circuit board	5322 276 11242	1	6	5.2.
Function switch complete	5322 278 80181	2	7	5.2.
VRPP connector X1005	5322 265 61022	1	6	5.4.

Printed circuit board

<i>Pos. nr.</i>	<i>Description</i>	<i>Ordering code</i>	<i>Qty</i>	<i>Item</i>	<i>Fig.</i>
	Knobs ranging	5322 414 60037	4	18	5.4.
	Knob preset	5322 414 20043	1	15	5.4.
	Knob power switch	5322 414 20033	1	16	5.4.
	Knobs zero set	5322 414 60036	2	19	5.4.
S3001		5322 276 14338	1	18	5.4.
S3002		5322 276 14338	1	18	5.4.
S3003		5322 276 14338	1	18	5.4.
S3004		5322 276 14338	1	18	5.4.
S3005		5322 276 14338	1	18	5.4.
S3006		5322 276 14338	1	18	5.4.
S3007		5322 276 14338	1	18	5.4.
S3008		5322 276 14338	1	18	5.4.
S1009	Power switch	5322 276 84077	1	16	5.4.
X1001	Input socket	5322 267 30544	1	17	5.4.
X1002	Input socket	5322 267 30544	1	17	5.4.
X1003	Input socket	5322 267 30544	1	17	5.4.
F1601	Thermal fuse	5322 252 20117	1	8	5.2.
F1300	Fuse 630MA	4822 253 30018			
F1600	Fuse 50MA	4822 253 30003			
T1600	Mains transformer	5322 148 80164	1	8	5.2.
T1601	Transformer	5322 144 14011	1	9	5.2.
G1719	Lith. battery	5322 138 10095	1	10	5.2.
X1004		5322 267 54107			
X1600		5322 264 54061			
X1700		5322 266 44028			
X1701		5322 264 44064			
X1702		4822 266 40063			
X3001		4822 265 40157			
B1700	Crystal	4822 242 70323			
	Fuse holder	5322 256 34081	1	11	5.2.
	Mains cable	5322 321 10329			
	Test leads + test pins	5322 397 60086			

6.2. ADDITIONS TO THE PARTS LIST FOR PM2519/21 (battery version)

6.2.1. Resistors

Pos. nr.	Description	%		Ordering code
R9101	20	5	PR37	5322 116 55615
R9102	6.49	0.5	MR30	5322 116 55614
R9103	6.49	0.5	MR30	5322 116 55614
R9104	261	1	MR25	5322 116 54502
R9105	220	20	0.05W	4822 100 10019
R9106	825	1	MR25	5322 116 54541
R9201	100K	1	MR25	4822 116 51288
R9301	2.2K	20	0.06W	4822 100 10029
R9302	10K	1	MR25	4822 116 51253
R9303	4.22K	1	MR25	5322 116 50729
R9304	100K	1	MR25	4822 116 51288
R9305	10K	1	MR25	4822 116 51253
R9306	10K	1	MR25	4822 116 51253
R9401	26.1K	1	MR25	5322 116 54651
R9402	154	1	MR25	5322 116 50506
R9403	6.19K	1	MR25	5322 116 55426
R9404	16.2K	1	MR25	5322 116 55361
R9405	4.7K	20	0.05W	4822 100 10036
R9406	5.36K	1	MR25	5322 116 54597
R9501	464	1	MR25	5322 116 50536
R9502	14.7K	1	MR25	5322 116 54632

6.2.2. Semi-conductors

V9101	BZV46-C2VD			4822 130 31248
V9102	BY527			4822 130 31509
V9201	BY527			4822 130 31509
V9202	BAW62			4822 130 30613
V9203	BAW62			4822 130 30613
V9301	BC557B			4822 130 44568
V9401	BD140			4822 130 40824
V9402	BC557B			4822 130 44568
V9403	BZX79-C3V9			4822 130 31981
V9501	BC369			5322 130 44593
V9502	BAW62			4822 130 30613
V9503	BZX79-C24			4822 130 34398
V9504	BAW62			4822 130 30613
V9505	BAW62			4822 130 30613
V9506	BAX12A			5322 130 34605
V9507	BAX12A			5322 130 34605

6.2.3. Capacitors

C9101	1000UF	-10+50%	16V	4822 124 20777
C9201	15UF	10%	16V	4822 124 20977
C9401	2.2UF	20%	16V	4822 124 10204
C9402	33UF	40%	10V	4822 124 20945
C9501	100UF	-10+50%	10V	4822 124 20679
C9502	270PF	2%	100V	4822 122 31331
C9503	47UF	-10+50%	25V	4822 124 20699
C9504	47UF	-10+50%	25V	4822 124 20699

<i>Pos. nr.</i>	<i>Description</i>	<i>Ordering code</i>
6.2.4. Integrated circuits		
A9101	LM317	4822 209 80591
A9401	CA3086	5322 209 86236
6.2.5. Miscellaneous		
L9501		5322 158 10052
L9502		5322 158 10052
T9501	Transformer	5322 148 84081
VL9101	Fuse	4822 253 20018
	Cable to 2519	5322 321 20856
	Cable to battery	5322 321 20591

6.3. ADDITIONS TO THE PARTS LIST FOR PM 2519/51

6.3.1. Galvanic separation

6.3.1.1. Resistors

<i>Pos. nr.</i>	<i>Description</i>			<i>Ordering code</i>
R501	2.49K	1	MR25	5322 116 50581
R502	3.65K	1	MR25	5322 116 54587
R503	3.65K	1	MR25	5322 116 54587
R504	3.65K	1	MR25	5322 116 54587
R505	2.49K	1	MR25	5322 116 50581
R506	787K			5322 116 52161
R507	16K2			5322 116 55361
R508	287E			5322 116 54506
R509	100	1	MR25	5322 116 55549
R510	287E			5322 116 54506
R511	100	1	MR25	5322 116 55549
R512	16K2			5322 116 55361
R513	787K			5322 116 52161
R514	2.49K	1	MR25	5322 116 50581
R515	3.65K	1	MR25	5322 116 54587
R516	3.65K	1	MR25	5322 116 54587
R517	2.49K	1	MR25	5322 116 50581
R518	3.65K	1	MR25	5322 116 54587
R519	2.49K	1	MR25	5322 116 50581
R520	3.65K	1	MR25	5322 116 54587
R521	3.65K	1	MR25	5322 116 54587
R522	3.65K	1	MR25	5322 116 54587
R523	2.49K	1	MR25	5322 116 50581
R524	787K			5322 116 52161
R525	16K2			5322 116 55361
R526	287E			5322 116 54506
R527	100	1	MR25	5322 116 55549
R528	787K			5322 116 52161
R529	16K2			5322 116 55361
R530	287E			5322 116 54506
R531	100E			5322 116 55549
R532	2.49K	1	MR25	5322 116 50581
R533	3.65K	1	MR25	5322 116 54587
R534	3.65K	1	MR25	5322 116 54587
R535	2.49K	1	MR25	5322 116 50581
R536	3.65K	1	MR25	5322 116 54587
R537	681E			4822 116 51233
R538	121K	1	MR25	5322 116 54704
R539	3K48			5322 116 55367
R540	10K	1	MR25	4822 116 51253
R541	10K	1	MR25	4822 116 51253
R542	100E	1	MR25	5322 116 55549
R543	14.7	1	MR25	5322 116 50412
R544	10K	1	MR25	4822 116 51253
R545	10K	1	MR25	4822 116 51253

<i>Pos. nr.</i>	<i>Description</i>		<i>Ordering code</i>
R546	10K	1	MR25
R547	10K		
R548	16K2		
R549	16K2		
R550	16K2		
R551	16K2		
R562	267E		

6.3.1.2. *Capacitors*

C501	10UF	50%	16 V	5322 124 14066
C503	10NF	100 V		4822 122 31414
C504	10NF	100V		4822 122 31414
C507	10NF	100V		4822 122 31414
C509	10NF	100V		4822 122 31414
C510	1UF	40%	25V	4822 124 20944
C511	1UF	40%	25V	4822 124 20944
C512	10UF	50%	16V	5322 124 14066
C513	2200UF	10%	100 V	4822 124 21382
C514	100NF	10%	100V	5322 121 40323
C520	1NF	400V		5322 122 40364
C521	1NF	400V		5322 122 40364

6.3.1.3. *Semi-conductors*

V501	BC559B			4822 130 44358
V502	BC547B			4822 130 40959
V503	BC547B			4822 130 40959
V504	BSX20			4822 130 41705
V506	BSX20			4822 130 41705
V508	BC559B			4822 130 44358
V509	BC547B			4822 130 40959
V510	BC547B			4822 130 40959
V511	BC559B			4822 130 44358
V512	BC547B			4822 130 40959
V513	BC547B			4822 130 40959
V514	BSX20			4822 130 41705
V516	BSX20			4822 130 41705
V518	BC559B			4822 130 44358
V519	BC547B			4822 130 40959
V520	BC547B			4822 130 40959
V522	BYV27-150			4822 130 31628
V523	BYV27-150			4822 130 31628
V524	BYV27-150			4822 130 31628
V525	BYV27-150			4822 130 31628
V526	BZV85-C18			5322 130 32212
V527	BZV85-C18			5322 130 32212
V528	BC559B			4822 130 44358
V529	BC327			4822 130 40854

6.3.1.4. *Integrated circuits*

A501	LM 393P			4822 209 81223
A502	LM 393P			4822 209 81223
A521	UA 7805			5322 209 84841

<i>Pos. nr.</i>	<i>Description</i>	<i>Ordering code</i>	<i>Qty</i>	<i>Item</i>	<i>Fig.</i>
6.3.1.5. Miscellaneous					
B501	Opto coupler CNX36*	5322 130 90175	1		
B502	Opto coupler CNX36*	5322 130 90175	1		
B503	Opto coupler CNX36*	5322 130 90175	1		
B504	Opto coupler CNX36*	5322 130 90175	1		
B505	Opto coupler CNX36*	5322 130 90175	1		
T501	Transformer	5322 148 80164	1	1	5.7.
F501	Thermal fuse	5322 252 20117	1		
X1500	Connector 5P	5322 264 50122	1		
X1501	Connector 5P	5322 264 50122	1		
	Cable mains con. + galv. separation	5322 321 20862	1	2	5.7.
	Cable mains galv. separation + main p.c.b.	5322 321 20854	1	3	5.7.
	Flatcable IEC galv.	5322 321 20863	1	4	5.7.
	Flatcable IEC 2519	5322 321 20864	1	5	5.7.
	Top cover assy	5322 447 70079			
X1	Mains connector	5322 267 40511	1		
	Mains cable	5322 321 20867			

* Selected types

<i>Pos. nr.</i>	<i>Description</i>				<i>Ordering code</i>
6.3.2. IEC-bus interface					
6.3.2.1. Resistors					
R601	10K	1	MR25	4822 116 51253	
R602	100	1	MR25	5322 116 55549	
R603	100	1	MR25	5322 116 55549	
R604	10K	1	MR25	4822 116 51253	
R605	100K	1	MR25	4822 116 51268	
R606	1M	1	MR25	5322 116 55535	
R607	2.74K	1	MR25	5322 116 50636	
R608	4.64K	1	MR25	5322 116 50484	
R609	8.66K	1	MR25	5322 116 54613	
R610	10K			4822 116 51253	
R611	10K			4822 116 51253	
R612	10K			4822 116 51253	

6.3.2.2. Capacitors					
C601	33UF	40%	10V	4822 124 20945	
C602	1UF	40%	25V	4822 124 20944	
C603	33UF	40%	10V	4822 124 20945	
C604	10NF	100V		4822 122 31414	
C605	10NF			4822 122 31414	
C606	10NF			4822 122 31414	
C607	33UF			4822 124 20945	
C608	33PF			4822 122 31067	
C609	33PF			4822 122 31067	

6.3.2.3. Semi-conductors					
V601	BAW62			4822 130 30613	
V602	BAW62			4822 130 30613	
V603	BAW62			4822 130 30613	
V604	BAW62			4822 130 30613	
V605	BAW62			4822 130 30613	
V606	BAW62			4822 130 30613	
V607	BAW62			4822 130 30613	
V608	BAT85			4822 130 31983	

6.3.2.4. Integrated circuits					
D601	MAB 8440/D036			5322 209 82221	
D602	SN 75161			5322 209 81842	
D603	SN 75160			5322 209 81807	
D604	HEF40245BD			5322 209 10867	
D605	N74LS02N	SC		5322 209 85312	
D606	N74LS05N	SC		5322 209 84994	

6.3.2.5. Miscellaneous

<i>Pos.</i>	<i>Description</i>	<i>Ordering number</i>	<i>Qty</i>	<i>Item</i>	<i>Fig.</i>
X601	Connector 24P	5322 285 51041	1	6	5.7.
X602	Connector 5P	5322 284 50122	1		
B601	Crystal 6MHZ	4822 242 70392	1	8	5.7.
S601	DIP switches	5322 277 60217	1	7	5.7.
	Plastic ring (input sockets)	5322 268 20141	3		

7. CIRCUIT DIAGRAMS AND PCB LAY-OUT

LIST OF FIGURES

Page

Fig.7.1.	Analog part	7-4
Fig. 7.2.	Digital part	7-9
Fig.7.3.	Power supply	7-13
Fig. 7.4.	Main pcb, lay-out, conductor side	7-14
Fig. 7.5.	Main pcb, lay-out component side	7-15
Fig. 7.6.	Switch pcb, lay-out, front view	7-18
Fig. 7.7.	Switch pcb, lay-out, rear view	7-16
Fig. 7.8.	Display pcb, lay-out component side	7-17
Fig. 7.9.	Display pcb, lay-out, conductor side	7-17
Fig. 7.10.	Preset pcb, lay-out, component side	7-18
Fig. 7.11.	Preset pcb, lay-out, conductor side	7-18
Fig. 7.12.	Battery power supply	7-20
Fig. 7.13.	Battery power supply pcb, lay-out, component side	7-20
Fig. 7.14.	Battery power supply pcb, lay-out, conductor side	7-20
Fig. 7.15.	Galvanic separation	7-21
Fig. 7.16.	Galvanic separation pcb, lay-out, component side	7-23
Fig. 7.17.	Galvanic separation pcb, lay-out, conductor side	7-23
Fig. 7.18.	IEC-625/IEEE-488 interface	7-24
Fig. 7.19.	IEC-625/IEEE-488 interface pcb, lay-out component side	7-25
Fig. 7.20.	IEC-625/IEEE-488 interface pcb, lay-out, conductor side	7-25

20

- 1
- 1
- 3
- 4
- 5
- 6
- 6
- 7
- 7
- 8
- 8
- 10
- 10
- 10
- 11
- 13
- 13
- 14
- 15
- 15

ANALOG PART

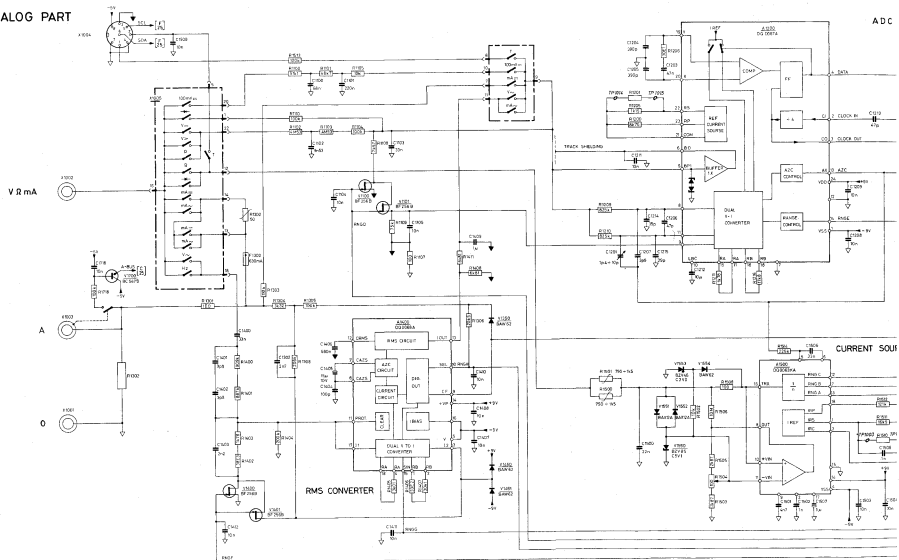
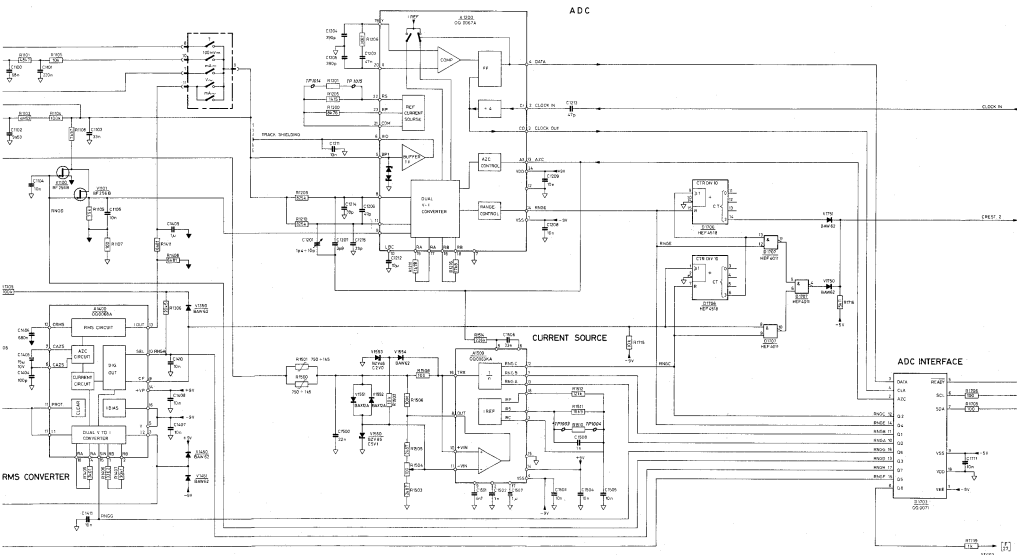
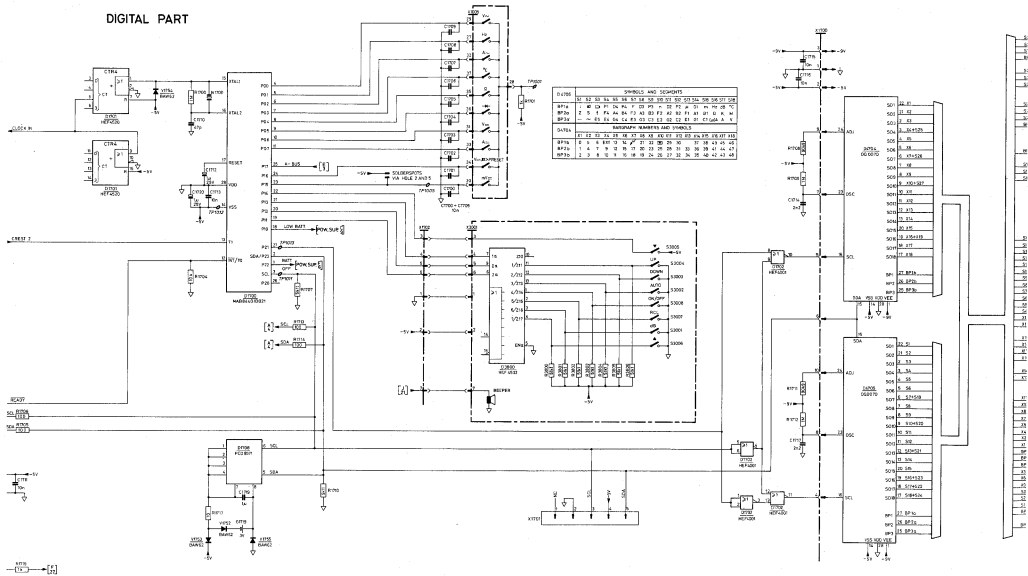

Fig. 7.1. Analog part



DIGITAL PART



SYMBOLS AND SIGNOTHS

04705	01	02	03	04	05	06	07	08	09	10	11	12	13	14	15	16	17	18	19	20	21	22	23	24	25	26	27	28	29	30	31	32	33	34	35	36	37	38	39	40	41	42	43	44	45	46	47	48	49	50	51	52	53	54	55	56	57	58	59	60	61	62	63	64	65	66	67	68	69	70	71	72	73	74	75	76	77	78	79	80	81	82	83	84	85	86	87	88	89	90	91	92	93	94	95	96	97	98	99	100
-------	----	----	----	----	----	----	----	----	----	----	----	----	----	----	----	----	----	----	----	----	----	----	----	----	----	----	----	----	----	----	----	----	----	----	----	----	----	----	----	----	----	----	----	----	----	----	----	----	----	----	----	----	----	----	----	----	----	----	----	----	----	----	----	----	----	----	----	----	----	----	----	----	----	----	----	----	----	----	----	----	----	----	----	----	----	----	----	----	----	----	----	----	----	----	----	----	----	----	----	-----

BATTERY WAVEFORMS AND SYMBOLS

04706	01	02	03	04	05	06	07	08	09	10	11	12	13	14	15	16	17	18	19	20	21	22	23	24	25	26	27	28	29	30	31	32	33	34	35	36	37	38	39	40	41	42	43	44	45	46	47	48	49	50	51	52	53	54	55	56	57	58	59	60	61	62	63	64	65	66	67	68	69	70	71	72	73	74	75	76	77	78	79	80	81	82	83	84	85	86	87	88	89	90	91	92	93	94	95	96	97	98	99	100
-------	----	----	----	----	----	----	----	----	----	----	----	----	----	----	----	----	----	----	----	----	----	----	----	----	----	----	----	----	----	----	----	----	----	----	----	----	----	----	----	----	----	----	----	----	----	----	----	----	----	----	----	----	----	----	----	----	----	----	----	----	----	----	----	----	----	----	----	----	----	----	----	----	----	----	----	----	----	----	----	----	----	----	----	----	----	----	----	----	----	----	----	----	----	----	----	----	----	----	----	-----

- 51
- 52
- 53
- 54
- 55
- 56
- 57
- 58
- 59
- 60
- 61
- 62
- 63
- 64
- 65
- 66
- 67
- 68
- 69
- 70
- 71
- 72
- 73
- 74
- 75
- 76
- 77
- 78
- 79
- 80
- 81
- 82
- 83
- 84
- 85
- 86
- 87
- 88
- 89
- 90
- 91
- 92
- 93
- 94
- 95
- 96
- 97
- 98
- 99
- 100

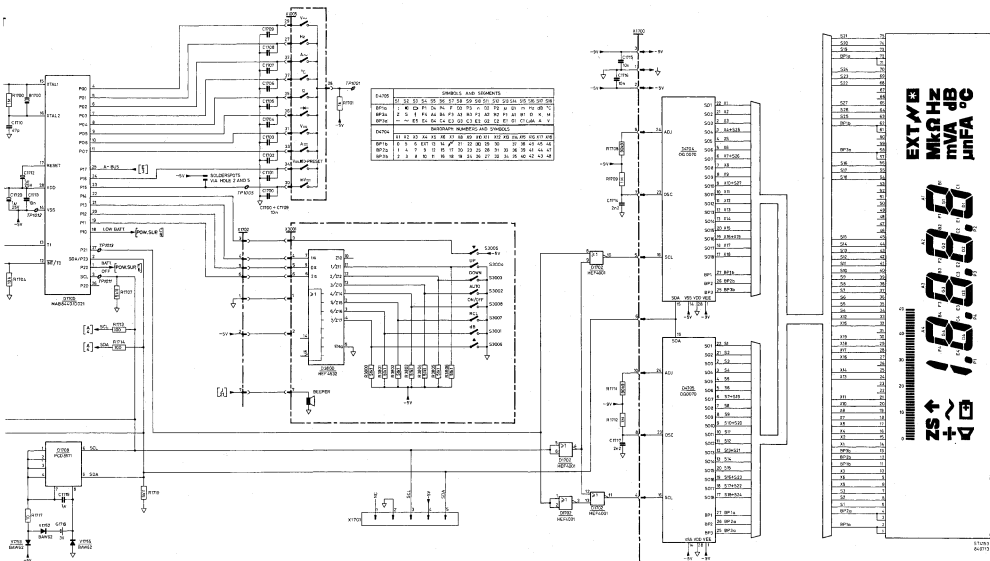

Fig. 7.2. Digital part

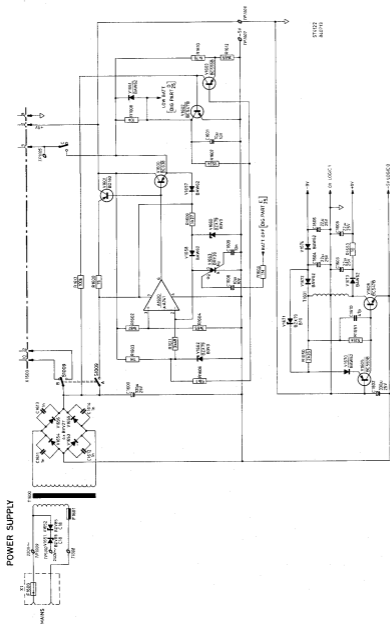

Fig. 7.3. Power supply

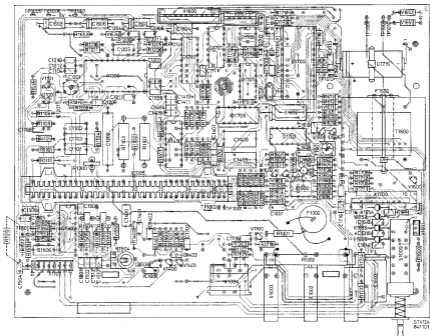

Fig. 7.4. Main p.c.b., lay-out, conductor side

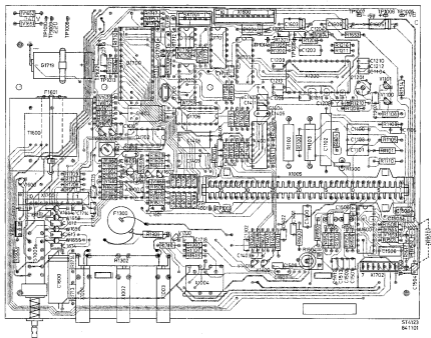

Fig. 7.5. Main p.c.b., lay-out, component

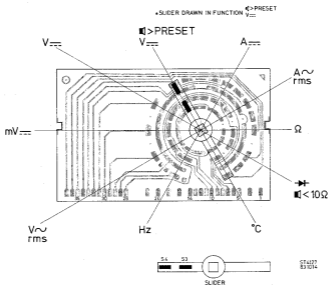

Fig. 7.6. Switch p.c.b., lay-out, front view

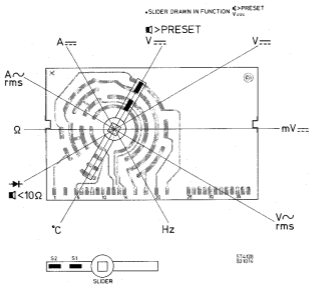

Fig. 7.7. Switch p.c.b., lay-out, rear view

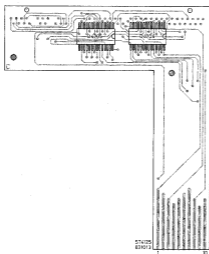

Fig. 7.8. Display p.c.b., lay-out, component side

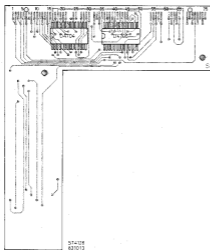

Fig. 7.9. Display p.c.b., lay-out, conductor side

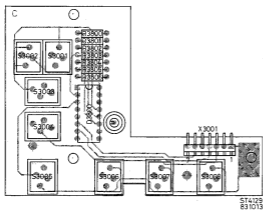

Fig. 7.10. Preset p.c.b., lay-out, component side

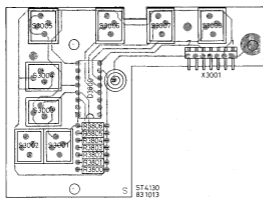

Fig. 7.11. Preset p.c.b., lay-out, conductor side

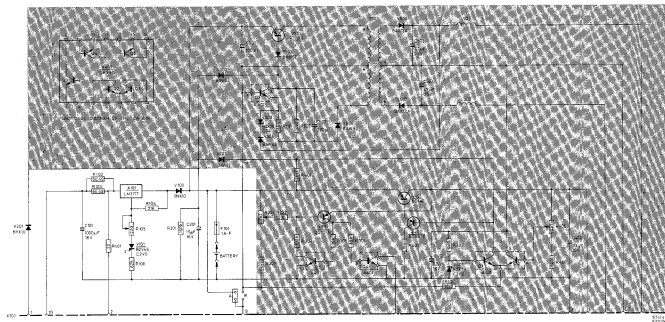

Fig. 7.12. Battery power supply

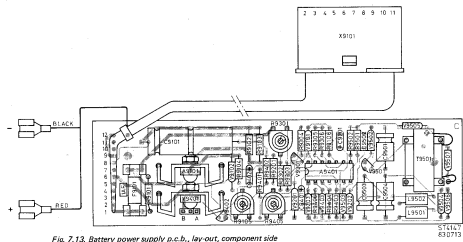

Fig. 7.13. Battery power supply p.c.b., lay-out, component side

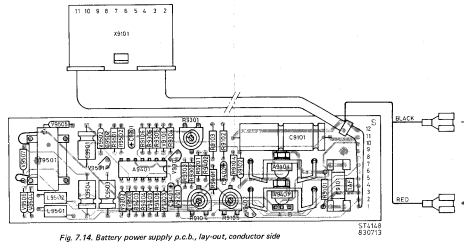

Fig. 7.14. Battery power supply p.c.b., lay-out, conductor side

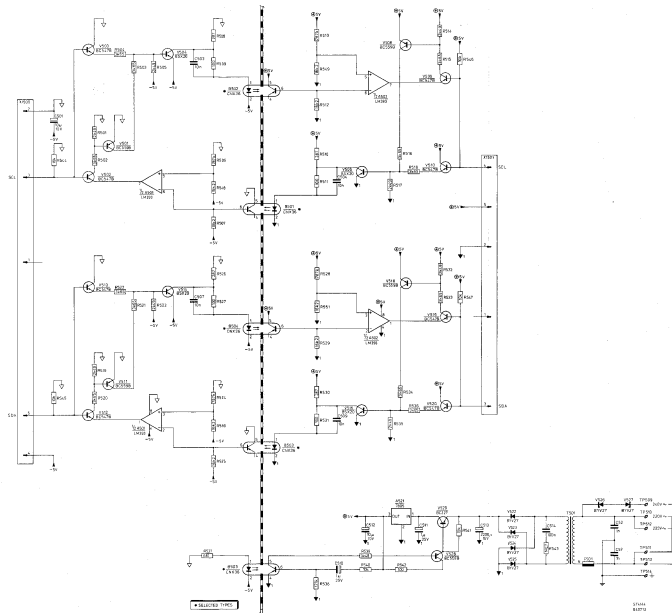

Fig. 7.15. Galvanic separation

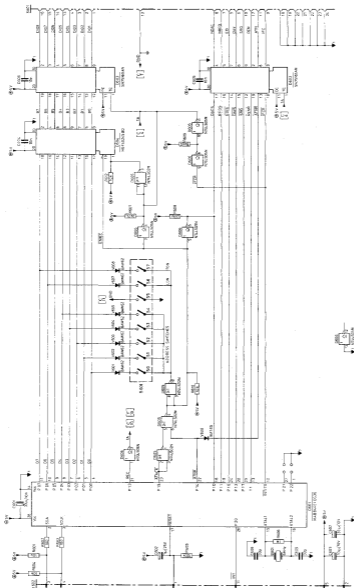
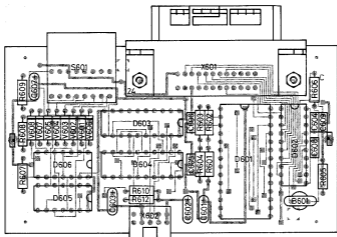
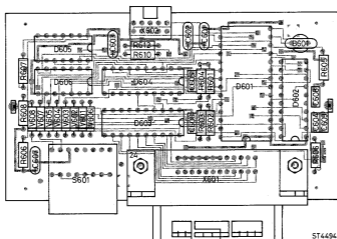

Fig. 7.18. IEC-625/IEEE-488 interface p.c.b., lay-out, component side



ST4493
841001

Fig. 7.19. IEC-625/IEEE-488 interface pcb, lay-out component side



ST4494
841001

Fig. 7.20. IEC-625/IEEE-488 interface pcb, lay-out conductor side

8. ADAPTING TO THE LOCAL MAINS VOLTAGE

8.1. PM 2519/01/21

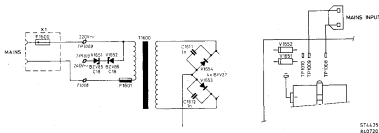

Fig. 8.1. Adaption to the local mains voltage PM 2519/01/21

Adaptation for	Connections
~ 220 V	TP1009 TP1008 (drawn)
~ 240 V	TP1010 TP1008

NOTE: The fuse F1001 is the same for both adaptations (50 mA).

8.2. PM 2519/51

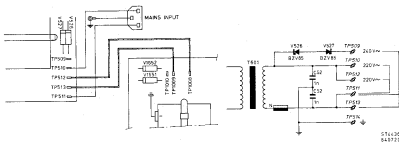

Fig. 8.2. Adaption to the local mains voltage PM 2519/51

Adaptation for	Connections
~ 220 V	TP510 TP511 (drawn)
~ 240 V	TP509 TP511

NOTE: In the PM 2519/51 the mains leads coming from the galvanic separation are for both adaptations always connected to TP1009 and TP1008 on the main p.c.b.
The fuse F1001 is the same for both adaptations (125 mA).

9. MODIFICATIONS

9.1. MODIFICATIONS TO THE PM 2518/01

This service manual is based on the instrument numbers DY 01 3611 and onwards. For the instruments with a lower number, the following modifications are given.

1. Modifications to main p.c.b. layout

For instruments with a serial no. lower than DY 01 2611 the following components are mounted at the solder side of the panel (Fig. 9.1.): V1755, R1105 and three wires. Also R1301 is connected in a different way.

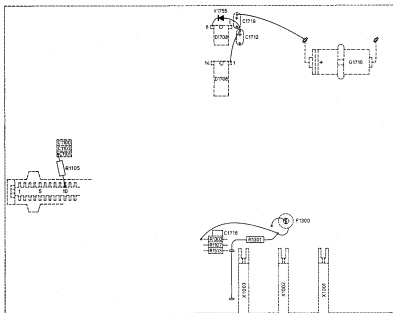

ST6427
84 1021

Fig. 9.1.

2. For instruments with a serial no. between DY 01 2411 and DY 01 3810, R1105 is mounted on the solder side of the panel (Fig. 9.2).

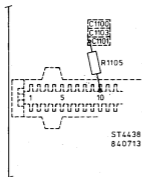

Fig. 9.2.

9.2. MODIFICATIONS TO THE PM 2519/51

This service manual, also for the PM2519/51, is based on the instruments numbers DY 5101236 and onwards. For instruments with a lower number the following modifications are given.

For instruments with a lower number than DY 51672 the IEC p.c.b. is supplied with a piggy-back processor. This is a MAB8440 with a 4K ROM on the back (see Fig. 9.3.). For the circuit diagram refer to Fig. 7.18.

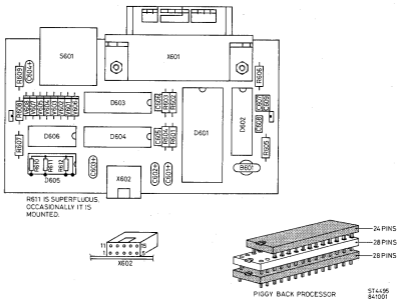
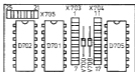
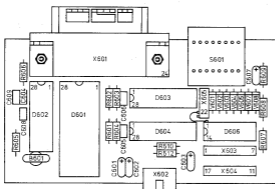
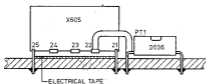
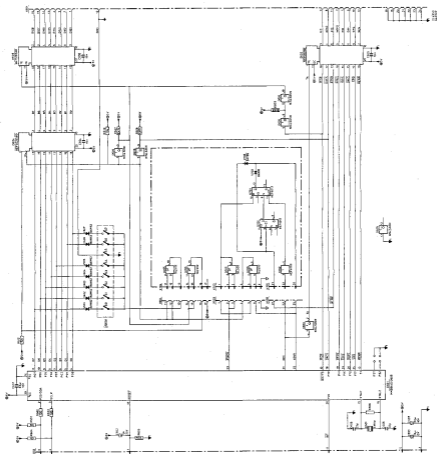

Fig. 9.3.

For instruments with a serial number DY 51672 up to DY 5101236 the piggy-back processor is replaced by a MAB8440/D026 with internal ROM (mask programmed ROM). Due to a fault in the software the IEC-bus p.c.b. must be adapted as follows:



ST4143
82078



10. COMPONENT DATA

HEF4001B QUADRUPLE 2-INPUT NOR GATE

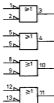

Functional diagram

ST4481
840713

Pinning diagram

HEF4011B QUADRUPLE 2-INPUT NAND GATE

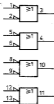

Functional diagram

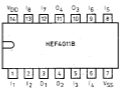
ST4462
840713

Pinning diagram

HEF4518B DUAL BCD COUNTER

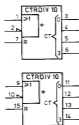

Functional diagram

PINNING

CP_{0A} , CP_{0B} clock inputs (L to H triggered)

CP_{1A} , CP_{1B} clock inputs (H to L triggered)

MR_A , MR_B master reset inputs

O_{0A} to O_{3A} outputs

O_{0B} to O_{3B} outputs



Pinning diagram

FUNCTION TABLE

CP_0	\overline{CP}_1	MR	Mode
L	H	L	counter advances
L	X	L	counter advances
X	L	L	no change
X	X	L	no change
H	L	L	no change
H	X	L	no change
X	X	H	O_0 to $O_3 = LOW$

H = HIGH state (the more positive voltage)

L = LOW state (the less positive voltage)

X = state is immaterial

— = positive-going transition

- = negative-going transition

HEF4520B DUAL BINARY COUNTER

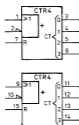

Functional diagram

PINNING

CP_{0A} , CP_{0B} clock inputs (L to H triggered)

\overline{CP}_{1A} , \overline{CP}_{1B} clock inputs (H to L triggered)

MR_A , MR_B master reset inputs

O_{0A} to O_{3A} outputs

O_{0B} to O_{3B} outputs

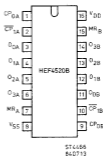

Pinning diagram

FUNCTION TABLE

CP_0	\overline{CP}_1	MR	Mode
L	H	L	counter advances
L	X	L	counter advances
X	X	L	no change
X	X	L	no change
H	X	L	no change
X	X	H	O_0 to $O_3 = LOW$

H = HIGH state (the more positive voltage)

L = LOW state (the less positive voltage)

X = state is immaterial

↑ = positive-going transition

↓ = negative-going transition

HEF4532B 8-INPUT PRIORITY ENCODER



Functional diagram



Pinning diagram

ST4487
840713

PINNING

- I₀ to I₇ priority inputs
- E_{in} enable input
- E_{out} enable output
- GS group select output
- O₀ to O₂ outputs

TRUTH TABLE

E _{in}	I ₇	I ₆	I ₅	I ₄	I ₃	I ₂	I ₁	I ₀	GS	O ₂	O ₁	O ₀	E _{out}
L	X	X	X	X	X	X	X	X	L	L	L	L	L
H	L	L	L	L	L	L	L	L	L	L	L	L	H
H	H	X	X	X	X	X	X	X	H	H	H	H	L
H	L	H	X	X	X	X	X	X	H	H	H	H	L
H	L	L	H	X	X	X	X	X	H	H	L	H	L
H	L	L	L	H	X	X	X	X	H	H	L	L	L
H	L	L	L	L	H	X	X	X	H	L	H	H	L
H	L	L	L	L	L	H	X	X	H	L	H	L	L
H	L	L	L	L	L	L	H	X	H	L	L	H	L
H	L	L	L	L	L	L	L	H	H	L	L	H	L

H = HIGH state (the more positive voltage)

L = LOW state (the less positive voltage)

X = state is immaterial

HEF40245B OCTAL BUS TRANSCEIVER WITH 3-STATE OUTPUTS

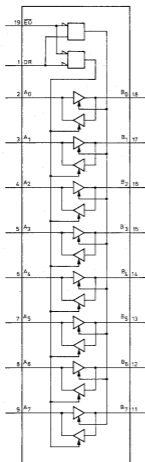

Functional diagram

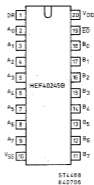

Pinning diagram

PINNING

A_0 to A_7	data input/output
B_0 to B_7	data input/output
DR	direction input
$\overline{E_0}$	output enable input

FUNCTION TABLE

Inputs		Inputs/outputs	
$\overline{E_0}$	DR	A_n	B_n
L	L	$A = B$	input
L	H	input	$B = A$
H	X	Z	Z

H = HIGH state (the more positive voltage)

L = LOW state (the less positive voltage)

X = state is immaterial

Z = high impedance OFF-state

SN75160A, SN75161A
IEEE-488 GPIB BUS TRANSCEIVERS
SN75160A
IN DUAL-IN-LINE PACKAGE
(TOP VIEW)

Table of abbreviations

514551

CLASS	NAME	IDENTITY
CONTROL INPUTS	DC PE TE	Direction Control Pull-up Enable Talk Enable
SN75160A I/O PORTS	B D	Bus side of device Terminal side of device
SN75161A/162A SIGNAL MNEMONICS	ATN DAV EOI IFC NDAC NRFD REN SRQ SC	Attention Data Valid End of Identify Interface Clear Not Data Accepted Not Ready for Data Remote Enable Service Request System Controller

Description

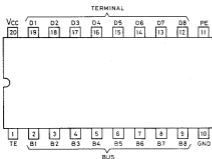
These octal bus transceivers are designed to provide communication on the general-purpose interface bus (GPIB) between operating units of the instrumentation system.

The sixteen signal lines normally required by the interface system can be implemented with two devices. The SN75160A handles the eight-line data bus. The data-transfer and bus-management signals are handled by the SN75161A in systems with one controller, or by the SN75162A in systems with more than one. An active turn-off feature has been incorporated into the bus-terminating resistors so that the devices exhibit a high impedance to the bus when $V_{CC} = 0$ V.

When PE is low, the bus outputs of the SN75160A have the characteristics of open-collector outputs. They act as three-state ports when PE is high. Taking TE low places those ports in the free-state, wherein they can be driven by the bus lines, and enables the D outputs.

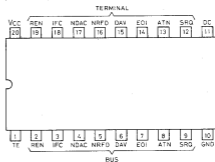
SN75161A
N DUAL-IN-LINE PACKAGE
(TOP VIEW)

514552

SN75160A function tables

Drivers		Receivers	
INPUTS	OUTPUT	INPUTS	OUTPUT
D TE PE	B	B TE PE	D
H H H	H	L L X	L
L H H	L	H L X	H
H X L	F	X H X	Z
L H L	L		
X L X	F		

SN75161A function table

CONTROL ¹		DIRECTION OF DATA ²							
TE	DC	ATN Level	EOI	REN	IFC	SRQ	NRFD	NDAC	DAV
H	H	R	R	T	R	R	T	R	R
H	H	L	R	R	R	R	T	R	R
H	L	X	T	T	T	R	R	R	Y
L	H	X	R	R	R	T	T	T	R
L	L	H	T	R	T	R	T	T	R
L	L	L	T	T	T	R	T	T	R

¹F = free state, H = high level, L = low level, X = irrelevant, Z = high-impedance state. ²This is the high-impedance state of a normal 3-state output modified by the internal resistors to V_{CC} and ground.

OQ 0063 Programmable Current Source

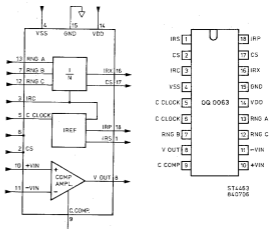

Pin nr. Name Description

Pin nr.	Name	Description																														
1	Irs	Ref. current adjustment With R_s the output current can be adjusted.																														
2	Cs	Smoothing Capacitor Smoothing capacitor for the switched currents.																														
3	Irc	I Ref Common Common connection of R_s and R_p .																														
4	Vss	Supply Negative supply voltage																														
5	C clock	Capacitor for the clock-oscillator.																														
6	C clock																															
7	RNG B	Range B Range information (see 12, 13).																														
8	V out	Output voltage Output of the compensation amplifier.																														
9	C comp.	C. Compensation Compensation capacitor for the compensation amplifier.																														
10	+Vin	+ Input + and - input of the compensation/protection amplifier.																														
11	-Vin	- Input Compensation: With the amplifier the current consumption of the ADC is compensated during Ω measurements. Protection: With the amplifier also the leak current through the protection diodes during Ω measurements is compensated.																														
12	RNG C	Range C																														
13	RNG A	Range A Together with signal RING B the signals determine the digital range information from the OQ 0059.																														
		<table border="1"> <thead> <tr> <th>Range</th> <th>Measuring current</th> <th>RNG A</th> <th>RNG B</th> <th>RNG C</th> </tr> </thead> <tbody> <tr> <td>1 kΩ</td> <td>1 mA</td> <td>1</td> <td>1</td> <td>1</td> </tr> <tr> <td>10 kΩ</td> <td>100 μA</td> <td>0</td> <td>0</td> <td>0</td> </tr> <tr> <td>100 kΩ</td> <td>10 μA</td> <td>1</td> <td>0</td> <td>0</td> </tr> <tr> <td>1 MΩ</td> <td>1 μA</td> <td>0</td> <td>1</td> <td>0</td> </tr> <tr> <td>10 MΩ</td> <td>100 nA</td> <td>1</td> <td>1</td> <td>0</td> </tr> </tbody> </table>	Range	Measuring current	RNG A	RNG B	RNG C	1 k Ω	1 mA	1	1	1	10 k Ω	100 μ A	0	0	0	100 k Ω	10 μ A	1	0	0	1 M Ω	1 μ A	0	1	0	10 M Ω	100 nA	1	1	0
Range	Measuring current	RNG A	RNG B	RNG C																												
1 k Ω	1 mA	1	1	1																												
10 k Ω	100 μ A	0	0	0																												
100 k Ω	10 μ A	1	0	0																												
1 M Ω	1 μ A	0	1	0																												
10 M Ω	100 nA	1	1	0																												
14	Vdd	Supply Positive supply voltage.																														
15	GND	GROUND Supply zero.																														
16	I out	Output current.																														
17	Cs	Smoothing capacitor.																														
18	Irp	With R_p the temperature-coefficient of the reference current is determined.																														

OQ 0067A ADC

PINNING & PIN FUNCTIONS

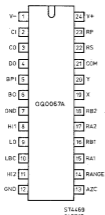

Pin number	Name	Description
1	V~	Most negative supply & substrate
2	CI	Clock Input
3	CO	ADC Clock Output
4	DO	ADC Data Output
5	BP1	Buffer & Protection Input
6	BO	Buffer Output
8, 11	HI1,2	ADC HI Inputs
9	LO	ADC LO Input
10	LBC	Low Buffer Capacitor
7, 12	GND	Digital Ground
13	AZC	AZC Input
14	RANGE	Range Input
15, 17	RA1, 2	Range Resistor A
16, 18	RB1, 2	Range Resistor B
19, 20	X, Y	Integrator Capacitor
21	COM	Common point for current source resistors
22	RS	Series Resistor
23	RP	Parallel Resistor
24	V+	Most positive supply

TOP VIEW

NOTE: Pin numbers 7 and 12 are not connected together internally.

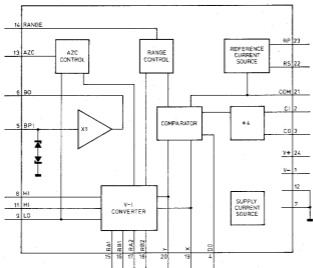

OQ 0068 RMS CONVERTER

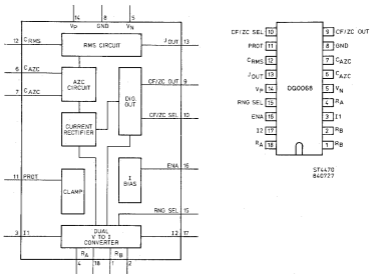

Pin nr.	Name	Description
1	RB	Range resistor B
2	RB	Range resistor B
3	I1	Input 1
4	RA	Range resistor A
5	VN	Negative supply
6	CAZ	Autozero capacitor
7	CAZ	Autozero capacitor
8	GND	Ground
9	CF/ZC OUT	Digital output
10	CF/ZC SEL	Digital output select
11	PROT	Input protection clamp
12	CRMS	Integrating capacitor
13	JOUT	Current output
14	VP	Positive supply
15	RNG SEL	Range selection
16	ENA	Enable input
17	I2	Input 2
18	RA	Range resistor A

OPERATION MODES

ENA	SEL CF/ZC	SEL RNG	FUNCTION
1	X	X	Power down mode
0	1	0	Low range Measurement mode
0	1	1	High range Measurement mode
0	0	0	Low range Counter mode
0	0	1	High range Counter mode

OQ 0070 DISPLAY DRIVER

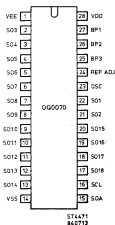

Name	Pin no.	Description
SO1-SO8	2-13	Driver outputs
	17-22	
BP1-BP3	25-27	Back planes
REF ADJ	24	Voltage reference adjustment
SDA	15	Serial data line
SCL	16	Serial clock line
VEE	1	Neg. voltage supply
VDD	28	Ground
VSS	14	Pos. voltage supply

Pinning OQ 0070
(Top view)

BLOCK DIAGRAM

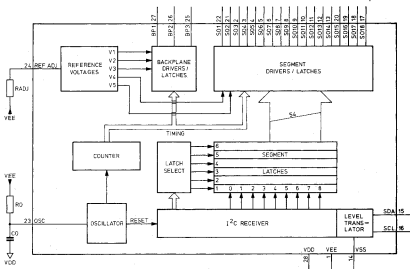

00 0071 ADC INTERFACE



Name	Pin nr.	Description
VEE	1	Neg. voltage
AZC	2	Automatic zero control to ADC
Data	3	Data signal from ADC
CLK	4	Clock input
Ready	5	Ready output
SCL	6	Serial clock line
SDA	7	Serial data line
VSS	9	Positive voltage
00...7	8,10-17	Outputs
VDD	18	Ground

(Top view)

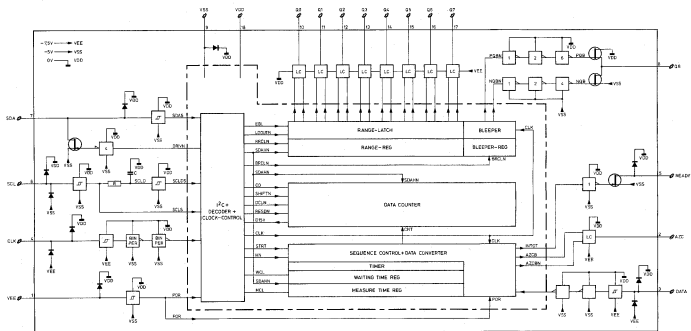

PCD8571 128 x 8-BIT STATIC RAM

General description

The PCD8571 is a low-power 1024-bit static CMOS/RAM, organized as 128 words of 8 bits each. Data and address are transferred serially via a two-line bidirectional bus (I^2C). Automatic word address incrementing in read/write modes minimizes bus traffic. Three hardware address pins A0, A1 and A2 identify when several devices are connected on the bus, which allows the use of up to 8 RAMs without additional hardware.

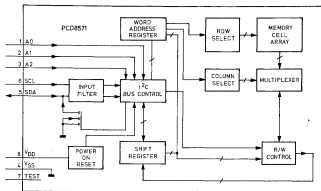

Block diagram

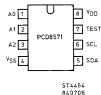

Pinning diagram

PINNING

1 to 3	A0 to A2	Address inputs	
4	VSS	Negative supply	
5	SDA	Serial data line	} I^2C bus
6	SCL	Serial clock line	
7	TEST	Test input for test speed-up; must be connected to VSS when not in use (power down mode, see figures)	
8	VDD	Positive supply	